





**SALES AND MARKETING  
UPDATE**



**HMAS**

**April 2025**



# Topics

- Products and Price List
- Video
- Tooling
- Marketing
- Did You Know...

# Products and Price List Update

# Products and Price List Update

- VF-7SS, VF-8SS, VM-8, GM-1, GM-1XT release in all regions
- HSG-3063, COBOT PKG-30KG, SR-4020, SR-4020P release in US/Canada/Mexico
- PHONE CHARGER added as standard on all machines in all regions
- CHIP WASHDOWN added as standard on VF-1/2, DT-3, and DM-3 in all regions
- STAINLESS WAY COVERS added as standard on VS, HDC, EC in all regions
- ROBOT PKG-1: new install kit UMC-400 HRP-1 SIDE available for side loading UMC-400/400SS
- ROBOT PKG-7KG:
  - New install kit UMC-400 HRP-7 SIDE available for side loading UMC-400/400SS
  - New install kit MM HRP-7 SIDE available for side loading MM/SMM/MM-EDU
  - New install kit DC FRNT HRP-7 INST available for front loading DC-2, DC-2/40
- MILL SPDL C-AXIS option added on 40T VF, VM, GM-2 in US/Canada/Mexico
- 10K-40T-GREASE-IN option added to DM in all regions
- BROKEN TOOL DETECT changed from standard to optional on UMC-400/400SS in all regions
- MULTI-STAGE CLT PUMP added as standard on all DC, DT-3, and DM-3 in all regions
- Transformer options, 8M, HOME, MFININ, RTAP-3, and SO options added to SR-3015P in all regions
- DRAWER CART option removed from all robots/cobots in all regions

# Products and Price List Update

- VF-7SS, VF-8SS, VM-8, GM-1, GM-1XT release in all regions



## VF-7SS

Starting Price: ~~US\$183,995~~

SALE > US\$174,795.25

Save 5% Now - Contact your HFO to Save Up to 15%

The Haas high-performance Super-Speed vertical machining centers provide the high spindle speeds, fast rapids, and quick tool changes necessary for high-volume production and reduced cycle times. Each SS machine features a 12,000-rpm inline direct-drive spindle, an ultra-fast side-mount tool



## VF-8SS

Starting Price: ~~US\$196,995~~

SALE > US\$187,145.25

Save 5% Now - Contact your HFO to Save Up to 15%

The Haas high-performance Super-Speed vertical machining centers provide the high spindle speeds, fast rapids, and quick tool changes necessary for high-volume production and reduced cycle times. Each SS machine features a 12,000-rpm, inline direct-drive spindle, an ultra-fast side-mount tool changer, and high-speed rapids on all axes. **The VF-8SS offers 8" (203 mm) more Y-axis travel than the VF-6SS.**

- More X-axis travel
- High-speed spindle
- Fast rapids



## VM-8

Starting Price: ~~US\$205,995~~

The Haas VM Series machines are high-performance VMCs that provide the accuracy, rigidity, and thermal stability required for mold making, tool & die work, and other high-precision industries. Each machine features a generous work cube, a multi-fixturing table, and a 12,000-rpm inline direct-drive spindle. Standard features include the Haas high-speed control with full look-ahead, a side-mount tool changer, a programmable coolant nozzle, an automatic air gun, and much more.

- Inline direct-drive spindle
- Side-mount tool changer
- Multi-fixturing table
- High-speed machining software

40  
TAPER

3  
AXIS

12k  
RPM

30+1  
TOOL CAPACITY

# Products and Price List Update

- VF-7SS, VF-8SS, VM-8, **GM-1, GM-1XT** release in all regions



## GM-1

**Starting Price: ~~US\$199,995~~**

**SALE - US\$189,995.25**

**Save 5% Now - Contact your HFO to Save Up to 15%**

The GM-1 is a heavy-duty 3-axis gantry mill designed for large-part machining, such as airframe components, large plates, and long extrusions. The machine's rigid cast-iron construction provides a very stable cutting platform, and a 1" (25 mm) thick aluminum table is standard. A traveling guard protects the operator from chips and coolant, and keeps the workspace clean.

- Robust 40-taper inline direct-drive spindle

GM-1: June

GM-1XT: Q4



## GM-1XT

**Starting Price: ~~US\$249,995~~**

**SALE - US\$237,495.25**

**Save 5% Now - Contact your HFO to Save Up to 15%**

The GM-1XT is an extended version of our 3-axis GM-1 gantry mill, providing 21" (533 mm) more X-axis travel for longer parts, such as airframe components, large plates, and long extrusions. The machine's rigid cast-iron construction provides a very stable cutting platform, and a 1" (25 mm) thick aluminum table is standard. A traveling guard protects the operator from chips and coolant, and keeps the workspace clean.

- Robust 40-taper inline direct-drive spindle
- 62" (1575 mm) between columns for large parts
- Rigid cast-iron construction
- Traveling guard for chip and coolant containment
- 1" (25 mm) thick aluminum table

40  
TAPER

3  
AXIS

8.1k  
RPM

30+1  
TOOL CAPACITY

# Products and Price List Update

- HSG-3063, COBOT PKG-30KG, SR-4020, SR-4020P release in US/Canada/Mexico



## HSG-3063 Surface Grinder

**Starting Price: US\$49,995**

The Haas HSG-3063 fully automatic surface grinder provides precision ground surfaces to critical sizes and finishes. Includes an 8" (200 mm) diameter grinding wheel and a 12" x 25" (300 x 600 mm) electromagnetic chuck.

- High-speed 1450-rpm spindle
- Automatic X-, Y-, and Z-axis feed
- Rapid Z-axis feed for quick height set up
- Automatic rough, finish, and spark-out cycles
- Automatic central lube system

**NOTE: Requires ISO32 hydraulic oil (not included).**

[Get Quote](#)

[COMPARE MACHINES](#)

[EXPLORE ALL INVENTORY](#)

Currently available for order in the US, Canada, and Mexico only, with Q3 2025 delivery.

# Products and Price List Update

- HSG-3063, **COBOT PKG-30KG**, SR-4020, SR-4020P release in US/Canada/Mexico



## Haas 30 kg Cobot Package

**Starting Price: ~~US\$69,995~~ US\$59,995**

**All-in-one cobot kit for your new machine!** The Haas 30 kg Cobot Package includes everything required to run your new cobot directly from the Haas control. This kit features the **HC30 Cobot** with a 30 kg capacity, dual pneumatic grippers, protective barriers, a temporary mounting base\*, a parts table, a part flip station, and all necessary hardware and cables.

**30 KG CAPACITY | 1800 MM REACH**

**AVAILABLE ON:**

**Medium and large VFs, ST-30/Y/L, ST-35/Y/L, UMC-750/SS, UMC-1000/SS, and UMC-1250/SS**

*\*Does not ship pre-built. The temporary mounting base is for optional use, and is not included in Europe. Floor mounting is recommended. Cobot carries a one-year warranty.*

## HC30 Machine Ready Cobot Kit

The **Haas Cobot Package-30kg** is a fully integrated, plug-and-play, 30 kg capacity collaborative robot for Haas machines. The system is controlled entirely by the Haas control when connected to the machine's electrical interface box. Includes: 6-axis cobot, software interface for direct control through the Haas machine, teach pendant and cobot controller, safety light curtain, and all necessary electrical hardware to interface directly with the Haas control.

**AVAILABLE ON:**

**Verticals: VF-3/SS/YT/SSYT, VF-4/SS, VF-5/SS, VF-6/SS, VF-7/SS, VF-8/SS, VF-9, VF-10, VF-11, VM-3, VM-6, VM-8**

**5-Axis Machines: UMC-750/SS, UMC-1000/SS, UMC-1500/SS**

**Lathes: ST-30/Y/L/LY, ST-35/Y/L/LY, DS-30Y**

**Includes:**

- ✓ HC30 Cobot
- ✓ 2 Meter Light Curtain
- ✓ Dual Pneumatic Grippers
- ✓ Fixed-Height Stand: 21.5" (546 mm)
- ✓ Parts Table
- ✓ Parts Template
- ✓ Permanent Anchoring Hardware



**NOTE:** Temporary mounting base not included in Europe

# Products and Price List Update

- HSG-3063, COBOT PKG-30KG, SR-4020, **SR-4020P** release in US/Canada/Mexico



## SR-4020 Sheet Router

Starting Price: **US\$39,995**

ER32 Collet  
TAPER

3  
AXIS

18k  
RPM

1  
TOOL CAPACITY

COMPARE MACHINES

## SR-4020P Sheet Router w/ATC Build-&Price

Base Price  
**US\$49,995**

Current Configuration

Spindles

Tool Changers

The Haas Control

Product Options

Warranty

### WARRANTY



**6-MONTH STANDARD WARRANTY**

[DETAILS >](#)

STANDARD



## SR-4020P Sheet Router w/ATC

Starting Price: **US\$49,995**

Haas SR Series sheet routers are affordable alternatives to gantry-style milling machines for cutting lighter materials, such as wood, plastics, high-density foam, and composites. Powered by the industry-leading Haas control, SR Series routers provide a level of programmability and functionality not found in other CNC routers.

The **SR-4020P** is equipped with an **24,000-rpm ISO30-taper spindle** and an **8-station linear tool changer** for high productivity and fully automated operation. It includes a PVC **vacuum table** with selectable zones, and a 7.4 hp (5.5 kW) **vacuum pump**. The machine's large travels easily accommodate full sheets of material, long extrusions, or multiple setups of smaller parts, and the intuitive Haas control interface and robust features make programming and adjustments easy – even for beginners.

**NOTE: The SR-3015P uses servomotor axis drives.**

- 24,000-rpm ISO30 integral motor spindle
- 8-station linear tool changer
- Built-in dust removal system
- Vacuum table with 7.4 hp (5.5 kW) pump
- Full-function, easy-to-use Haas control

ISO30  
TAPER

3  
AXIS

24k  
RPM

8  
TOOL CAPACITY

**Available for order in North America, Europe, and the UK only, with estimated delivery June 2025.**

# Products and Price List Update

- PHONE CHARGER added as standard on all machines in all regions



## Phone Charging Stand

*Standard on some models*

Phone mount and charger

# Products and Price List Update

- CHIP WASHDOWN added as standard on VF-1/2, DT-3, and DM-3 in all regions



## Chip Washdown Feature

Flush chips to the front of the machine

# Products and Price List Update

- STAINLESS WAY COVERS added as standard on VS, HDC, EC in all regions

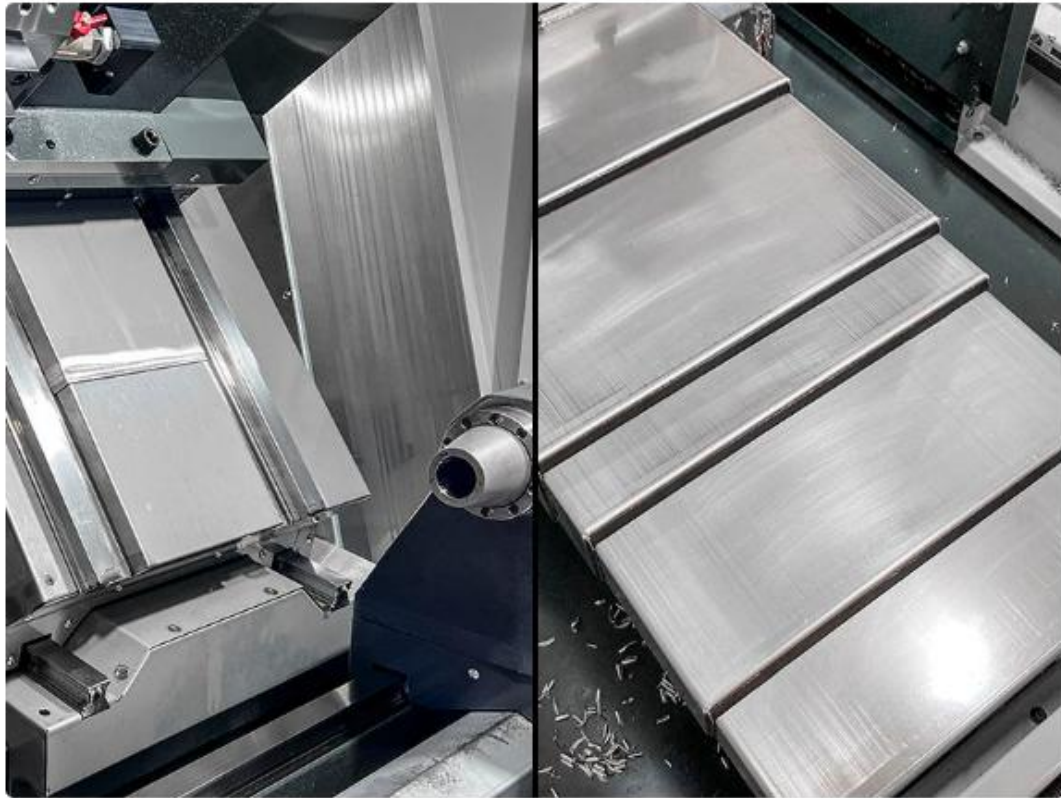

## Stainless Steel Way Covers

*Standard on some models*

Provide excellent corrosion resistance







- Heavy-gauge 304 stainless steel construction
- Excellent corrosion resistance and strength
- Aluminum wipers for smooth operation and long life

These heavy-gauge 304 stainless steel way covers provide high strength and longevity, as well as excellent resistance to chemical corrosion and rust.

# Products and Price List Update

- ROBOT PKG-1: new install kit UMC-400 HRP-1 SIDE for side loading UMC-400/400SS







## INSTALLATION KITS

 <p><b>ROBOT-1 SIDE INSTALL KIT, SMALL UMCS</b> DETAILS &gt; <span>sale</span></p>	 <p><b>ROBOT-1 INSTALLATION KIT, ST-10 TO ST-15</b> DETAILS &gt; <span>sale</span></p>
 <p><b>ROBOT-1 INSTALLATION KIT, ST-20 TO ST-28</b> DETAILS &gt; <span>sale</span></p>	 <p><b>ROBOT-1 FRONT INSTALL KIT, SMALL VMC</b> DETAILS &gt; <span>sale</span></p>
 <p><b>ROBOT-1 SIDE INSTALL KIT, UMC-400/SS</b> DETAILS &gt; <span>sale</span></p>	

# Products and Price List Update

- ROBOT PKG-7KG:
  - New install kit UMC-400 HRP-7 SIDE available for side loading UMC-400/400SS
  - New install kit MM HRP-7 SIDE available for side loading MM/SMM/MM-EDU
  - New install kit DC FRNT HRP-7 INST available for front loading DC-2, DC-2/40

### INSTALLATION KITS

 <p>7 KG ROBOT FRONT INSTALL KIT, SMALL VMC</p> <p>DETAILS &gt;</p> <p>sale</p>	 <p>7 KG ROBOT SIDE INSTALL KIT, SMALL UMCS</p> <p>DETAILS &gt;</p> <p>sale</p>
 <p>7 KG ROBOT SIDE INSTALL KIT, DT/DM, UMC-350HD</p> <p>DETAILS &gt;</p> <p>sale</p>	 <p>7 KG ROBOT INSTALLATION KIT, ST- 10 TO ST-15</p> <p>DETAILS &gt;</p> <p>sale</p>
 <p>7 KG ROBOT INSTALLATION KIT, ST- 20 TO ST-28</p> <p>DETAILS &gt;</p> <p>sale</p>	 <p>ROBOT-7KG SIDE INSTALL KIT, SMALL VMCS</p> <p>DETAILS &gt;</p> <p>sale</p>
 <p>7 KG ROBOT FRONT INSTALL KIT, DC</p> <p>DETAILS &gt;</p> <p>sale</p>	

# Products and Price List Update

- MILL SPDL C-AXIS option added on 40T VF, VM, GM-2 in US/Canada/Mexico



## Mill Spindle C-Axis Drive

**US\$14,995.00**

Accurate positioning for right-angle heads



OVERVIEW



DOCUMENTS



AVAILABLE ON THESE MACHINES

Our Mill Spindle C-Axis Drive allows you to accurately position right-angle milling heads to nearly any angle for milling, drilling, and tapping on multiple sides of a part, and at any angle.

**NOTE:** Requires a Haas mill with 4th-axis drive and NGC software version 100.21.000.1130. Machines with a single-axis rotary installed will require both 4th- and 5th-axis drives. Not compatible with 2-axis rotaries.

- ✓ Mill, drill, and tap on multiple sides of a part
- ✓ Mounts to the mill spindle
- ✓ Accurate positioning to nearly any angle

\*C-axis drive for VMC option (MILL SPDL C-AXIS): August

# Products and Price List Update

- 10K-40T-GREASE-IN option added to DM in all regions



## 10,000-rpm Inline Grease-Packed Spindle

*Standard on some models*

Optional inline spindle for 40-taper mills

10k  
SPEED

40  
TAPER

Inline  
DRIVE

# Products and Price List Update

- BROKEN TOOL DETECT changed from standard to optional on UMC-400/400SS all regions



## Broken Tool Detection

*Standard on some models*



- Available on all UMCs\*
- Safely stops the machine if a broken tool is detected
- Saves money by preventing damage to tooling, workholding, and possibly the machine

\*Except the UMC-350HD-EDU.

The Haas Broken Tool Detection system uses a built-in camera to visually compare tools before and after a tool change, to determine if the tool was damaged during machining. If a broken tool is detected, the machine generates an alarm, and prevents the tool from being swapped into the spindle.

# Products and Price List Update

- MULTI-STAGE CLT PUMP added as standard on all DC, DT-3, and DM-3 in all regions



## Multi-Stage Coolant Pump

*Standard on some models*

More flow, more pressure, less noise



OPTION INFO



OVERVIEW





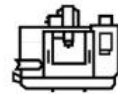













SERVICE DOCUMENTS



AVAILABLE ON THESE MACHINES

# Products and Price List Update

- Transformer options, 8M, HOME, MFININ, RTAP-3, and SO options added to **SR-3015P** in all regions

 <p><b>STANDARD LOW-VOLT TRANSFORMER</b>  <a href="#">DETAILS &gt;</a></p>	 <p><b>INTERNAL HIGH-VOLTAGE ISOLATED TRANSFORMER</b>  <a href="#">DETAILS &gt;</a></p> <p>US\$64/mo        US\$3,895</p>	 <p><b>ADVANCED TOOL MANAGEMENT</b>  <a href="#">DETAILS &gt;</a></p> <p>STANDARD</p>	 <p><b>MEDIA DISPLAY M-CODE; M130</b>  <a href="#">WATCH VIDEO &gt;</a></p> <p>STANDARD</p>
 <p><b>POWER SURGE PROTECTION</b>  <a href="#">DETAILS &gt;</a></p> <p>STANDARD</p>	 <p><b>8 SPARE M FUNCTIONS</b>  <a href="#">DETAILS &gt;</a></p> <p>US\$34/mo        US\$2,095</p>	 <p><b>HAASCONNECT: REMOTE MONITORING</b>  <a href="#">WATCH VIDEO &gt;</a></p> <p>STANDARD</p>	 <p><b>HAASDROP</b>  <a href="#">WATCH VIDEO &gt;</a></p> <p>STANDARD</p>
 <p><b>SECOND HOME POSITION</b>  <a href="#">WATCH VIDEO &gt;</a></p> <p>US\$18/mo        US\$1,095</p>	 <p><b>M-CODE/MFIN CABLE ASSEMBLY</b>  <a href="#">DETAILS &gt;</a></p> <p>US\$2/mo        US\$95</p>	 <p><b>VISUAL PART PROGRAMMING SYSTEM</b>  <a href="#">WATCH VIDEO &gt;</a></p> <p>STANDARD</p>	 <p><b>USER-DEFINABLE MACROS</b>  <a href="#">DETAILS &gt;</a></p> <p>STANDARD</p>
		 <p><b>HIGH-SPEED MACHINING</b>  <a href="#">WATCH VIDEO &gt;</a></p> <p>US\$60/mo        US\$3,695</p>	 <p><b>RIGID TAPPING</b>  <a href="#">DETAILS &gt;</a></p> <p>US\$31/mo        US\$1,895</p>
		 <p><b>SPINDLE ORIENTATION</b>  <a href="#">DETAILS &gt;</a></p> <p>US\$24/mo        US\$1,495</p>	 <p><b>COORDINATE ROTATION AND SCALING</b>  <a href="#">DETAILS &gt;</a></p> <p>US\$33/mo        US\$1,995</p>

# Products and Price List Update

- DRAWER CART option removed from all robots/cobots in all regions

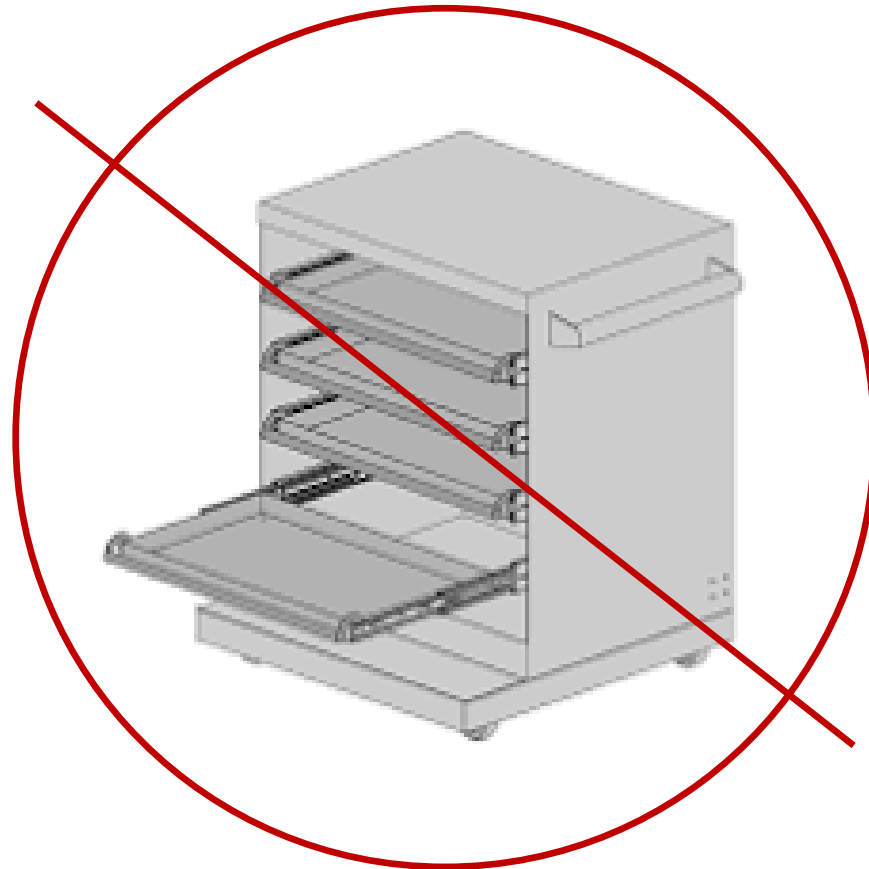

# Video Update

# Video Update

## Recently Released Videos

- Double-Station Fixed-Jaw Vises! Haas Workholding by Kurt - Haas Automation, Inc. - <https://www.youtube.com/watch?v=hYOwtZbjSI0>
- Move Tools Between Machines More Easily - The Haas Tool Cart - Haas Automation, Inc. - <https://www.youtube.com/watch?v=o9pTrlQbFDk>
- The Haas HDC-3-5AX Cutting Haas VF-4 Columns - Haas Automation, Inc. - <https://www.youtube.com/watch?v=2X8PwbgQXUE>
- Measure Your Vise Force - New Clamp Force Gauge on HaasTooling.com – <https://www.youtube.com/watch?v=liwfKhxw9zA>

# Video Update

## Recently Released Videos

- Double-Station Fixed-Jaw Vises! Haas Workholding by Kurt - Haas Automation, Inc. - <https://www.youtube.com/watch?v=hYOwtZbjSI0>

Haas Tooling Video

- Great Instructional Video
- Very Informative
- Check it out
- Share it as needed



# Video Update

## Recently Released Videos

- Move Tools Between Machines More Easily - The Haas Tool Cart - Haas Automation, Inc. - <https://www.youtube.com/watch?v=o9pTrlQbFDk>

Haas Tooling Video

- Great Tips & Tricks
- Check it out
- Share it



# Video Update

## Recently Released Videos

- The Haas HDC-3-5AX Cutting Haas VF-4 Columns - Haas Automation, Inc. - <https://www.youtube.com/watch?v=2X8PwbgQXUE>

### Haas Cutting Demo

- Shows off machine functions
- Great for understanding capabilities
- Check it out and learn
- Share it when needed



# Video Update

## Recently Released Videos

- Measure Your Vise Force - New Clamp Force Gauge on HaasTooling.com – <https://www.youtube.com/watch?v=liwfkHxw9zA>

### Haas Tooling Video

- Great Instructional Video
- Benefits of Force Gauge
- Great Value
- Check it out
- Share it



# Tooling Update



A promotional banner for a 'Spring Sale' featuring various Haas tooling products. The banner includes the text 'Spring Sale 7500+ tools on sale!' and a call to action for a 'WINNER'S CIRCLE' subscription. The subscription is advertised as 'FREE NEXT-DAY DELIVERY FOR 1-YEAR' for a price of '\$10', with a crossed-out price of '\$95' shown in parentheses. The background is green with a diagonal light effect, and the tools are displayed on the left side.

## WINNER'S CIRCLE Update

Still On Sale - Only \$10 – 90% off the already reduced price

Over 10,000 Subscriptions and Growing

# Tooling Update, Global Except Europe & China



Tooling Fixture Subplates

12 items



Bandsaw Blades

4 items



Spindle Reduction Sleeves / Liners

65 items

**+144 Items**



Safety Apparel

4 items



Machine Accessories

4 items



Scroll Chucks

5 items

- VF-4 Tooling Fixture Subplate Kit
- M42 Steel Bandsaw Blade
- Barfeeder Liners New Design
- Abrasion Resistant Work Gloves
- Coolant Tank Oil Skimmer
- 3 Jaw Scroll Chuck
- Lathe Collet Chucks and Accessories
- CNC Wood Router Bits



Quick-Change Collet Chucks

9 items



CNC Router Bits For Wood

35 items



## WINNER'S CIRCLE Update

Still On Sale - Only €10 – 90% off the already reduced price

Over 10,000 Subscriptions and Growing

# HAE - Tooling Update



Safety Apparel

4 items



ER Collet Chucks

55 items



Hand Cutting Tools

6 items



Hammers & Mallets

8 items

**+50 Items**



Quick-Change Collet Chucks

9 items



Boring Holders & Extensions

37 items



Height Setters

2 items

- Abrasion Resistant Work Gloves
- BT30 ER Collet Chuck
- Aviation Snips
- Rubber Mallets
- Lathe Collet Chucks and Accessories
- HSK63A Boring Head Holder
- Digital Height Setters

# Marketing Update

Spring INTO AUTOMATION

UP TO 15% OFF!

SALE EXTENDED TO APRIL 30<sup>TH</sup>

LEARN MORE

This banner features a red and yellow background with a stylized machine and tool icons. A red arrow points from the 'LEARN MORE' button to the 'In-Stock Machines' button in the navigation bar below.

HAAS TOOLING.COM

Spring Sale

7500+ tools on sale!

FREE NEXT-DAY DELIVERY FOR 1-YEAR

Sign up for WINNER'S CIRCLE

\$10 (\$95)

SHOP HAAS TOOLING

This banner features a green background with a white arrow pointing to the right. It includes images of various tools and a red banner for a \$10 offer.

Build-&-Price  
[Learn More >](#)

**In-Stock Machines**  
[Learn More >](#)

Unbeatable Financing  
[Learn More >](#)

Haas Tooling  
[Learn More >](#)

This navigation bar contains four buttons with icons: a price tag for 'Build-&-Price', a machine with a red tag for 'In-Stock Machines' (highlighted with a red border), a calculator for 'Unbeatable Financing', and a tool for 'Haas Tooling'. A red arrow points from the 'Spring INTO AUTOMATION' banner to the 'In-Stock Machines' button.

## GET MORE - SAVE MORE!

EXAMPLES OF HOW YOU CAN SAVE BIG WITH OPTIONS & AUTOMATION

**VF-2 + COBOT**

**15% OFF**



LEARN MORE

**UMC-500 + RPL**

**15% OFF**



LEARN MORE

**ST-20Y + ROBOT**

**15% OFF**



LEARN MORE

**VF-4SS + PALLET POOL**

**15% OFF**



LEARN MORE

**EC-400 + PALLET POOL**

**15% OFF**



LEARN MORE

**VF-2 + TRT160**

**15% OFF**



LEARN MORE

**DS-30Y + BAR FEEDER**

**15% OFF**



LEARN MORE

**DC-1/40 + TRT160**

**15% OFF**



LEARN MORE

## INSANE FINANCING FOR YOUR NEXT HAAS CNC

DOWN PAYMENT	CHOOSE YOUR TERM						
	12-MONTHS	24-MONTHS	36-MONTHS	48-MONTHS	60-MONTHS	72-MONTHS	84-MONTHS
10% DOWN	0.00%	0.99%	1.99%	2.99%	3.49%	N/A	N/A
20% DOWN	0.00%	0.00%	0.99%	1.49%	2.99%	3.99%	4.49%
25% DOWN	0.00%	0.00%	0.00%	0.99%	1.99%	3.49%	3.99%
30% DOWN	0.00%	0.00%	0.00%	0.00%	1.49%	2.99%	3.49%
20% DOWN + 3-MO SKIP	0.00%	0.49%	0.99%	2.49%	3.99%	4.49%	4.99%

APPLY FOR FINANCING TODAY

\* Financing Terms, Conditions, and Exceptions: References are to an implied interest rate under a conditional sales contract. Interest accrues during the skip period. Down payment, rate, and terms of financing are dependent upon credit approval.

Eligible businesses should have three or more years of operation under current ownership. U.S. and Canada only.

All programs are 10% - 30% down. Must put a minimum of 20% down to get no payments for 3 months.

**Certain equipment (e.g., stand-alone Rotaries, Shop Equipment, Bar Feeders, etc.) are subject to different rates, terms, and down-payment requirements, unless financed with a machine.** No prepayment penalty on any program. Not responsible for misprints or typographical errors. Offer valid on new machine orders placed from April 1 through April 30, 2025.

## Marketing Tools

View Edit Track Devel

\*\*\* All images are clickable \*\*\*



**MARKETING CAMPAIGNS**

[HAAS TOOLING HOME PAGE](#)

[Haas Tooling Promo page](#)

[How to redeem Online Tooling Promos](#)

[2025 AVAILABLE DIGITAL MARKETING CAMPAIGNS and MODEL GUIDES, PDFs, CATALOGS](#)

\*Check Marketing Campaign page for info about HFO Demo Day.

[Tooling Kits Explained \(08/PCK/EK\)](#)

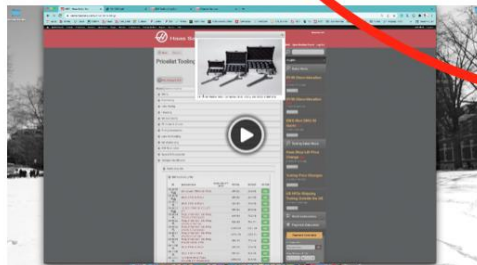

## HFO DEMO DAY \*2025!

**DEMO DAY 2025 THEME: "More Than..."**

We are promoting this upcoming Demo Day with the theme of: **"More Than..."**

- ✓ More than CNC, ✓ More than Tooling, ✓ More than Workholding,
- ✓ More than Shop Support, ✓ More than Robots, ✓ More than Automation,
- ✓ More than Rotary, ✓ More than...

HFOs will be presenting these "More than..." topics, but they can choose which specific machines and Haas Tooling items to display that best suit their markets and customers. Customers should walk away from Demo Day with a clear understanding that Haas and their HFO are about more than just machines and are their supplier of choice for all their machine shop needs.

**Updated Graphics coming soon!**

Fill out the survey below to start the process of getting marketing materials created for your Demo Day. You must submit the survey a minimum of 2 months before your event. *(If you have a non-Demo Day event, please fill out the survey for HFO EVENTS.)*

Date updated: Jan 2025

[DEMO DAY SURVEY](#)

[LANDING PAGE TEMPLATE](#)

A survey will be created to collect T-shirt orders. If your Demo Day is scheduled before the survey is available, please email [HFOEmailSupport@HaasCNC.com](mailto:HFOEmailSupport@HaasCNC.com).

**Email ↓**



# Marketing Campaign Update

## 2025 AVAILABLE DIGITAL MARKETING CAMPAIGNS + MODEL GUIDES/PDFS/CATALOGS

These campaigns will be running throughout 2025. Email [HFOEmailSupport@haascnc.com](mailto:HFOEmailSupport@haascnc.com) if you want to have Haas email your customer base regarding any of the below campaigns.

### CURRENT LIVE MARKETING CAMPAIGNS

#### NEW Marketing Campaigns added

- **Box Way Lathe** \*NEW
- **HFL-3015 Fiber Laser** \*NEW
- **DMs/DTs** \*NEW
- **Hot Deals on In-Stock Machines** \*NEW
- **Financing Rates** \*NEW
- **SR-3015 Sheet Router** \*NEW
- **HFO Demo Day** \*NEW
- **DC-Series** \*NEW

- Haas Makes It Easy
- Why Haas
- First-Time Buyers
- Small Footprint
- Affordable Machines

### TOOLING MARKETING CAMPAIGNS

- **Haas Cobot** \*NEW
- Benefits of Haas Tooling
- Haas Workholding by Kurt
- Ready2Run
- Ready2Machine

#### On Going Marketing Campaigns Available

- EU Models (*update coming soon*)
- Mini Mill Redesign
- Rotaries
- Customer Testimonials
- Showroom Machines/Local Inventory

PROMOTIONS

NEW PRODUCTS

GENERAL & MACHINE

TOOLING

PDFS AND BROCHURES

## NEW PRODUCT MARKETING CAMPAIGNS

- ✓ Band Saw
- ✓ Air Compressor
- ✓ Laser Marker
- ✓ CMM
- ✓ Surface Grinder

- ✓ Knee Mill
- ✓ UMC-400/SS
- ✓ DMs/DTs
- ✓ TL-P
- ✓ ST-40 Updates (short/long/Y-axis)

- ✓ DC Series
- ✓ SB Series
- ✓ SR-3015 and SR-3015P Sheet Router
- ✓ Robotic Pallet Loader
- ✓ Mini Max
- ✓ HFL-3015 Fiber Laser

**\*More New Machines Coming Soon!**



**Haas F1 Team**  
OFFICIAL MACHINE TOOL

## ALL NEW SB-28Y BOX WAY LATHE

Y-AXIS CNC BOX WAY LATHE WITH 12" X 18.5" MAX CAPACITY, A2-8, AND 2.95" BAR CAPACITY

Haas SB Series lathes offer the high dynamic stiffness, load-bearing capacity, and vibration damping associated with traditional box way machines, combined with the powerful, easy-to-use Haas control, and backed by the industry-leading support of the Haas Factory Outlet network.

**BY THE NUMBERS**

- A2-8** SPINDLE
- 10"** CHUCK SIZE
- 3200** RPM
- 40** HP
- 12" x 18.5"** MAX CAPACITY (DIA. x LENGTH)
- 2.95"** BAR CAPACITY

**STARTING AT: \$129,995**

Specifications subject to change without notice. Not responsible for typographical errors. Machines shown with optional equipment. Actual product appearance may differ. Pricing subject to change without notice.

**Haas F1 Team**  
OFFICIAL MACHINE TOOL

## You Asked, We Delivered: CNC Box Way Lathes for Heavy Turning.

**10" CHUCK SIZE**   **2.95" BAR CAPACITY**   **3200 RPM**   **40 HP**





**BOX WAY CONSTRUCTION**

- Hardened and precision ground ways
- Flame and induction hardened slide surfaces
- Hand-scraped Turcite-B slideways on the X and Y axes, and tailstock gib

Our SB Series boxway lathes are equipped with the same powerful, easy-to-use Haas Control found on every machine we build. Designed and built in-house – hardware and software – the Haas control is optimized specifically for Haas machine tools. It comes standard on every machine we sell, and is the same across the entire product line.

Each SB Series lathe is equipped with a robust 12-station BMT65 turret that accepts industry-standard base-mount tooling, as well as axial and radial driven live tools for secondary milling, drilling, and tapping operations.

**30° SLANT-BED BASE CASTING WITH 30° Y-AXIS ANGLE FOR 60° TOTAL**

All SB Series box way lathes feature a true slant-bed design that provides excellent rigidity and thermal stability, as well as efficient chip evacuation. The slant bed also allows generous X-axis travel in a smaller footprint, and provides a sturdy base to support the turret along the entire Z-axis.

**DON'T FORGET THE TOOLING!**

We have thousands of high-quality tooling products at unbeatable low prices... and we're adding more every day at [www.HaasTooling.com](http://www.HaasTooling.com)

Haas Automation, Inc. USA  
2808 Shugu Rd., Newark, CA USA  
[www.HaasCNC.com](http://www.HaasCNC.com) | [www.HaasTooling.com](http://www.HaasTooling.com)

Haas Automation Europe  
Mortelstraat 28, B-1930 Zaventem, Belgium  
[www.HaasCNC.com](http://www.HaasCNC.com)

Low Prices • High Quality  
Fast & Free Delivery



**Haas F1 Team**  
OFFICIAL MACHINE TOOL

## THE NEW HAAS HFL-3015 FIBER LASER CUTTER

**IS HERE!**

**STARTING AT: \$139,995**

**HFL-3015 FIBER LASER CUTTER** is a fully enclosed 3 kW CNC fiber laser cutting machine with a high-speed sensor head and a large work area.

Scan here to contact your local Haas Factory Outlet.

Specifications subject to change without notice. Not responsible for typographical errors. Machines shown with optional equipment. Actual product appearance may differ. Pricing subject to change without notice.



**Haas F1 Team**  
OFFICIAL MACHINE TOOL

## You Asked, We Delivered: Fiber Laser Cutting Accuracy.

**5118 IPM** MAX SPEED   **1543 LB** MAX LOAD

- 3 kW fiber laser
- Autofocus laser head
- 120" x 60" (3050 x 1530 mm) work area
- Dual automatic-exchange work platforms
- Full enclosure for safety and protection
- High-strength machine bed for stability
- Negative pressure dust removal system

**HFL-3015 MATERIAL CUTTING RANGE**

MATERIAL	SAE	Metric
Carbon Steel	0.016" - 0.78"	0.4 - 19.8 mm
Stainless Steel	0.016" - 0.47"	0.4 - 11.9 mm
Aluminum	0.016" - 0.31"	0.4 - 7.9 mm
Brass	0.016" - 0.23"	0.4 - 5.95 mm

**FULLY OPTIMIZED** The 3 kW fiber laser cutting head is optimized to provide excellent cut quality and high efficiency, and features automatic focusing to reduce human intervention and increase accuracy. The laser easily cuts a variety of metals, including carbon steel, stainless steel, aluminum alloy, brass, copper, and even titanium alloy.

**MAXIMUM EFFICIENCY** The HFL-3015 has dual work platforms that are exchanged automatically, allowing raw material and finished parts to be loaded and unloaded on one platform, while the other platform is in the machine, providing near continuous operation.

**SPECIFICATIONS**

	SAE	Metric
Work Area Length x Width	120" x 60"	3050 x 1530 mm
X-Axis Travel	60"	1530 mm
Y-Axis Travel	120"	3050 mm
Z-Axis Travel	65.95"	1676 mm
Maximum Acceleration	1.26	1.26
Maximum Load on Table	1543 lb	700 kg
Machine Weight	13,772 lb	6340 kg
Dimensions L x W x H	232.7" x 88.4" x 81.9"	6450 x 2270 x 2090 mm
Power	3 phase 220V or 380V (with included transformer)	

**DON'T FORGET THE TOOLING!**

We have thousands of high-quality tooling products at unbeatable low prices... and we're adding more every day at [www.HaasTooling.com](http://www.HaasTooling.com)

Haas Automation, Inc. USA  
2808 Shugu Rd., Newark, CA USA  
[www.HaasCNC.com](http://www.HaasCNC.com) | [www.HaasTooling.com](http://www.HaasTooling.com)

Haas Automation Europe  
Mortelstraat 28, B-1930 Zaventem, Belgium  
[www.HaasCNC.com](http://www.HaasCNC.com)

Low Prices • High Quality  
Fast & Free Delivery

# HAE Marketing Update

**SPRING SALE EXTENDED TO 30 APRIL!**  
SAVE UP TO 15%!

*Spring INTO* **AUTOMATION** **-15%**

**Spring Sale**  
**2000+ tools on sale!**

**FREE EXPRESS DELIVERY FOR 1-YEAR** Sign up for WINNER'S CIRCLE  
**10€** (95€)

**EU SERIES: UP TO 34% OFF**  
MORE CHOICES, MORE VALUE – JUST FOR EUROPE

Machines Configured Exclusively for Europe

**Build-&-Price**  
Learn More >

**In-Stock Machines**  
Learn More >

**Unbeatable Financing**  
Learn More >

**Haas Tooling**  
Learn More >

LEARN MORE

SHOP HAAS TOOLING

# HAE Marketing Update

GET MORE - **SAVE MORE!**  
EXAMPLES OF HOW YOU CAN SAVE BIG WITH OPTIONS & AUTOMATION

**VF-2 + COBOT**

**-15%**



[LEARN MORE](#)

**ST-20Y + ROBOT**

**-15%**



[LEARN MORE](#)

**EC-400 + PALLET POOL**

**-15%**



[LEARN MORE](#)

**VF-2 + TRT160**

**-15%**



[LEARN MORE](#)

**DS-30Y + BAR FEEDER**

**-15%**



[LEARN MORE](#)

**DC-1/40 + TRT160**

**-15%**



[LEARN MORE](#)

# HAE Marketing Update

## CHOOSE YOUR FINANCING

**NO MODEL  
RESTRICTIONS**

**UP TO 3-MONTH SKIP  
AVAILABLE**

**NO PRE-PAYMENT  
PENALTIES EVER!**

LOWEST DOWN PAYMENT  
**10% DOWN**

3,49% Interest for as Long as 60-Months.

Payments as Low as  
**€1.637 PER MONTH**

LOWEST INTEREST  
**0% FOR 48 MONTHS**

Requires Larger Down Payment.

Payments as Low as  
**€1.458 PER MONTH**

LONGEST TERM  
**84-MONTH TERM**

With Rates as Low as 3,49%\*

Payments as Low as  
**€940 PER MONTH**

Sample payments are based on a €100.000 CNC machine purchase.

**SAVE €9.845 IN INTEREST!**

(Based on 0,00% for 48 months, compared to lenders with similar terms at 6,66% interest.)

\*Financing terms, conditions, and exceptions: valid in Denmark, Germany, France, Spain, Portugal, Belgium, Luxembourg, Estonia, Latvia, Lithuania, Czech Republic, Slovenia, Slovakia, and Greece only. References are to an implied interest rate under a conditional sales contract. Interest accrues during the skip period. Down payment, rate, and terms of financing are dependent upon credit approval. Eligible businesses should have three or more years of operation under current ownership. All programs are 10% - 30% down. Must put a minimum of 20% down to get no payments for 3 months. **Certain equipment (e.g., stand-alone Rotaries, Shop Equipment, Bar Feeders, etc.) are subject to different rates, terms, and down-payment requirements, unless financed with a machine.** No prepayment penalty on any program.

Offer valid on new machine orders placed from 1 April 2025 - 30 April 2025.

## INSANE FINANCING FOR YOUR NEXT HAAS CNC

DOWN PAYMENT	CHOOSE YOUR TERM						
	12-MONTHS	24-MONTHS	36-MONTHS	48-MONTHS	60-MONTHS	72-MONTHS	84-MONTHS
10% DOWN	0,00%	0,99%	1,99%	2,99%	3,49%	N/A	N/A
20% DOWN	0,00%	0,00%	0,99%	1,49%	2,99%	3,99%	4,49%
25% DOWN	0,00%	0,00%	0,00%	0,99%	1,99%	3,49%	3,99%
30% DOWN	0,00%	0,00%	0,00%	0,00%	1,49%	2,99%	3,49%
20% DOWN + 3-MO SKIP	0,00%	0,49%	0,99%	2,49%	3,99%	4,49%	4,99%

\*Financing terms, conditions, and exceptions: valid in **Denmark, Germany, France, Spain, Portugal, Belgium, Luxembourg, Estonia, Latvia, Lithuania, Czech Republic, Slovenia, Slovakia, and Greece only.** References are to an implied interest rate under a conditional sales contract. Interest accrues during the skip period. Down payment, rate, and terms of financing are dependent upon credit approval. Eligible businesses should have three or more years of operation under current ownership. All programs are 10% - 30% down. Must put a minimum of 20% down to get no payments for 3 months. **Certain equipment (e.g., stand-alone Rotaries, Shop Equipment, Bar Feeders, etc.) are subject to different rates, terms, and down-payment requirements, unless financed with a machine.** No prepayment penalty on any program.  
 Offer valid on new machine orders placed from **1 April 2025 - 30 April 2025.**

# Did You Know...

# Did You Know...

## 6 Month Warranties

### SR-4020P Sheet Router w/ATC Build-&Price

Base Price **US\$49,995** Payments as low as **US\$818/mo** 60 months ▾

**Finish My Quote**

- Current Configuration
- Spindles
- Tool Changers
- The Haas Control
- Product Options
- Warranty** >

### WARRANTY

 **6-MONTH STANDARD WARRANTY**  
DETAILS > STANDARD ✓

**Upgraded Options**

**Total Price**  
US\$49,995



**HAAS KNEE MILL**  
VARIABLE SPEED R8 SPINDLE | AUTO LUBE | X/Y DRO | X-AXIS POWER FEED

[DOWNLOAD BROCHURE](#)

**CONFIGURATION**

**MACHINE INFO**

**SPECS**

**RELATED TOOLING**

**PRODUCT WARRANTY**



### Haas Product Warranty - 6 Months

This product includes a 6-month parts warranty and support by your local Haas Factory Outlet. On-site installation, training, service labor, and travel charges will apply. Contact your local Haas Factory Outlet.

# Did You Know...

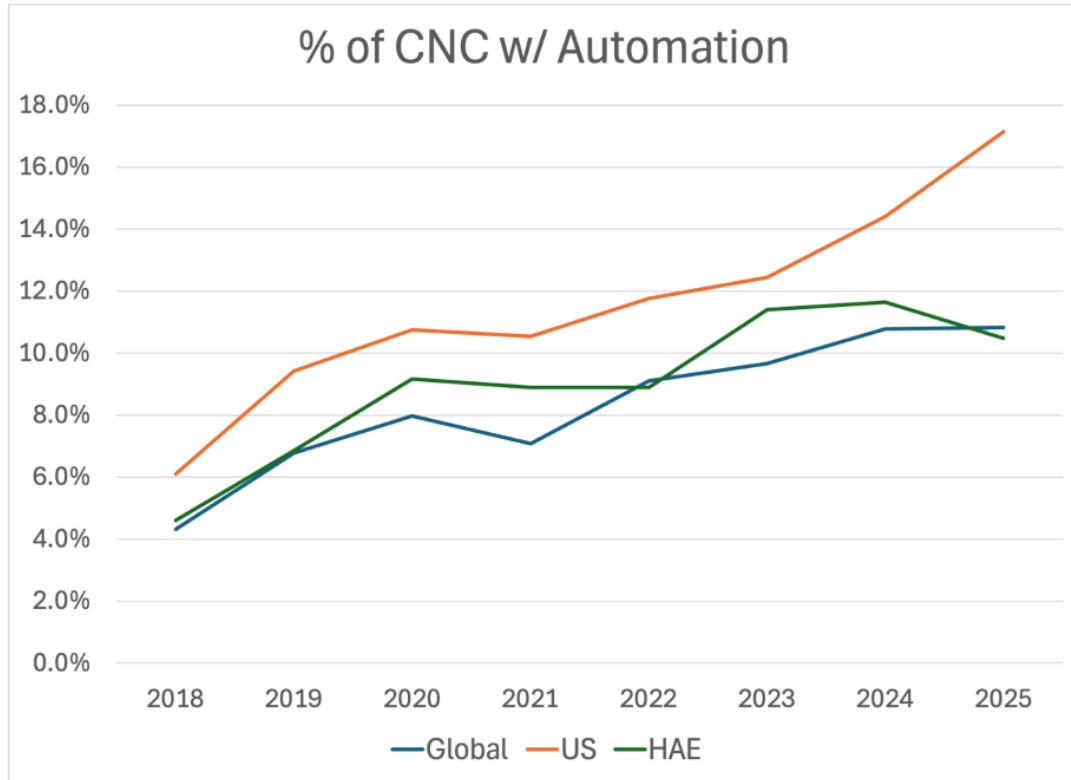

## Machine Models

- VF-1 to VF-4
- ST-10 to ST-35
- UMC-500 to UMC-1250

## Automation

- Barfeeders
- APLs
- PPs
- Robots
- Cobots

### HAE Dealer Meeting and Sales Training Presentations

View published | **New draft** | Moderate | Track | Devel

Submitted by *scottgasic* on Wed, 2025-03-05 17:41

Below are PDFs of the presentations that we given during last week's HAE Dealer Meeting and Sales Training. All HFOs are encouraged to review the material.

**Attachment:**

- 2025\_hae\_dealer\_meeting\_02-2025\_-\_final\_v2.pdf
- hae\_sales\_training\_-\_dealer\_meeting\_-\_haas\_tooling\_for\_sales\_reps.pdf
- hae\_sales\_training\_-\_dealer\_meeting\_-\_live\_demos\_in\_showroom.pdf
- hae\_sales\_training\_-\_dealer\_meeting\_-\_shop\_support\_equipment.pdf
- hae\_sales\_training\_-\_dealer\_meeting\_-\_success\_with\_automation.pdf**

English

Popups History

Sales News

**HST Server Maintenance** NEW  
4 days 13 hours ago

**April 2025 Price Lists Posted**  
6 days 15 hours ago

[https://sales.haascnc.com/sites/default/files/hae\\_sales\\_training\\_-\\_dealer\\_meeting\\_-\\_success\\_with\\_automation.pdf](https://sales.haascnc.com/sites/default/files/hae_sales_training_-_dealer_meeting_-_success_with_automation.pdf)

## Automation Success



### Advanced Product Design UMC-500SS Pallet Pool

- <https://www.youtube.com/watch?v=-n3M-qB0mjE>



### Customer Profile

- Location - OH
- Aftermarket Automotive
- Haas user since 2020
- Four Haas Machines
- Seven other CNCs
- No prior Automation Experience
- 22 Employees

4.6k/1mo (1/24/25)

## Automation Success – Advanced Product Design



### Observations...

- Started with UMC-750SS
- UMC-500SS Pallet Pool
- 3D Surfacing
- Combined Operations
- Consolidated Multiple Parts

- Diversity of Parts
- Pyramid Fixture w/ Multi-Parts
- 11 Pallets (10+1)
- Obtained 15 hours runtime (**17 now**)
- Use of Shrink-fit Tooling
- Use of Broken Tool Detection
- “Flawless Integration”
- “I’ll never buy another machine without Automation”
- “Another Machine on Order” – **Already delivered and running**

## Did You Know...

- **19" Monitor and Color Update**
  - Phasing in, **start month listed below for production**
- February
  - UMC-400/500, ST-30/35, DS-30Y, SR-3015P, DT-3, DM-3, SB-28Y, ST-40LY, GM-1
- March
  - UMC-750, VF-3/4/5, VR-5, VP-5, VM-3
- April
  - VF-1/2, VM-2
- May
  - UMC-1000/1250/1500, VF-6 to VF-14, ST-10 to ST-55, VR, VM
- June
  - DT, DM, EC, GM, HDC, VC, VS
- July
  - GR, GM, TM, TL, MM, CM, CL, Desktop, SR, Simulators



# Did You Know...

Shop Haas Tooling / Machine Maintenance / Machine Accessories / 06-0536



\* All prices and specifications subject to change without notice. Actual product appearance & included accessories may differ.

## Carbon Fiber Bezel, 15" Screen Cover

Part #: 06-0536  
15in CARBON FIBER CONTROL BEZEL, COVER

In Stock

Price: **\$87.95**

1

ADD TO CART



Winner's Circle Price: **\$83.55 (Save 5%)**

FREE DELIVERY



\* All prices and specifications subject to change without notice. Actual product appearance & included accessories may differ.

## Carbon Fiber Bezel, Storage Cabinet Cover

Part #: 06-0537  
CARBON FIBER STORAGE CABINET, COVER

In Stock

Price: **\$29.95**  
SALE > **\$14.97**

1

ADD TO CART



Winner's Circle Price: **\$14.22 (Save 5%)**

FREE DELIVERY



# Did You Know...

- **Stainless Way Covers**

- Phasing in, start month listed below for production

- Now Standard on:

- All VF, VM, VR
- ST-40Ys
- MM
- ST-20, 30L, 40
- CM/CL
- DT-3/DM-3
- ECs

- Coming soon:

- May – ST-10/30
- Q4 – DT/DM



- Factory Training Dates for 2025
  - June 18/19
  - September 10/11
  - December 3/4

Please email Scott Gasich directly with any names, email addresses and job functions for those who will be attending



**THANK YOU!**  
**FOR ALL YOUR EFFORTS**



**HMAS**

