





**SALES AND MARKETING  
UPDATE**



**HMAS**

**May 2025**



# Topics

- Products and Price List
- Video
- Tooling
- Marketing
- Did You Know...

# Products and Price List Update

# Products and Price List Update

- Add STAINLESS WAY COVERS as standard to ST-10/30 in all regions
- Add MULTI-STAGE CLT PUMP as standard to ST-30/35, DS, SB in all regions
- Add 64MM INSTALL KIT and 76MM INSTALL KIT options to HAAS BAR FEEDER V2 in all regions
- Add 2ND PALLET RACK option to RPL-25KG in all regions
- Change MPAL-630 and PAL-630 prices to \$3,995
- Expand LT350 release to all regions
- Add CBT-30 FRNT LRG UMC option to COBOT PKG-30KG in all regions
- Change COORD from optional to standard on SR-3015 and SR-4020 in all regions
- Change SO and COORD from optional to standard on SR-3015P and SR-4020P in all regions
- UMC-400:
  - Add 8.1K-40T-IN-15 as standard
  - Change 10K-40T-IN-15 from standard to optional
- Remove HFL-3015, HSG-3063, VF-2-I, VF-2SS-I, VF-2YT-I, VF-2SSYT-I, VF-4-I, VF-4SS-I, VF-5/40-I, VF-5SS-I from all price lists
- Expand UMC-400/400SS release to all regions
- Add WIDESCREEEN MONITOR as standard on UMC-1000/1250/1500, LG VMC, ST-10/20/40 in all regions



# Products and Price List Update

- STAINLESS WAY COVERS added as standard on ST-10/30 in all regions

## Stainless Steel Way Covers

*Standard on some models*

Provide excellent corrosion resistance



- Heavy-gauge 304 stainless steel construction
- Excellent corrosion resistance and strength
- Aluminum wipers for smooth operation and long life

These heavy-gauge 304 stainless steel way covers provide high strength and longevity, as well as excellent resistance to chemical corrosion and rust.

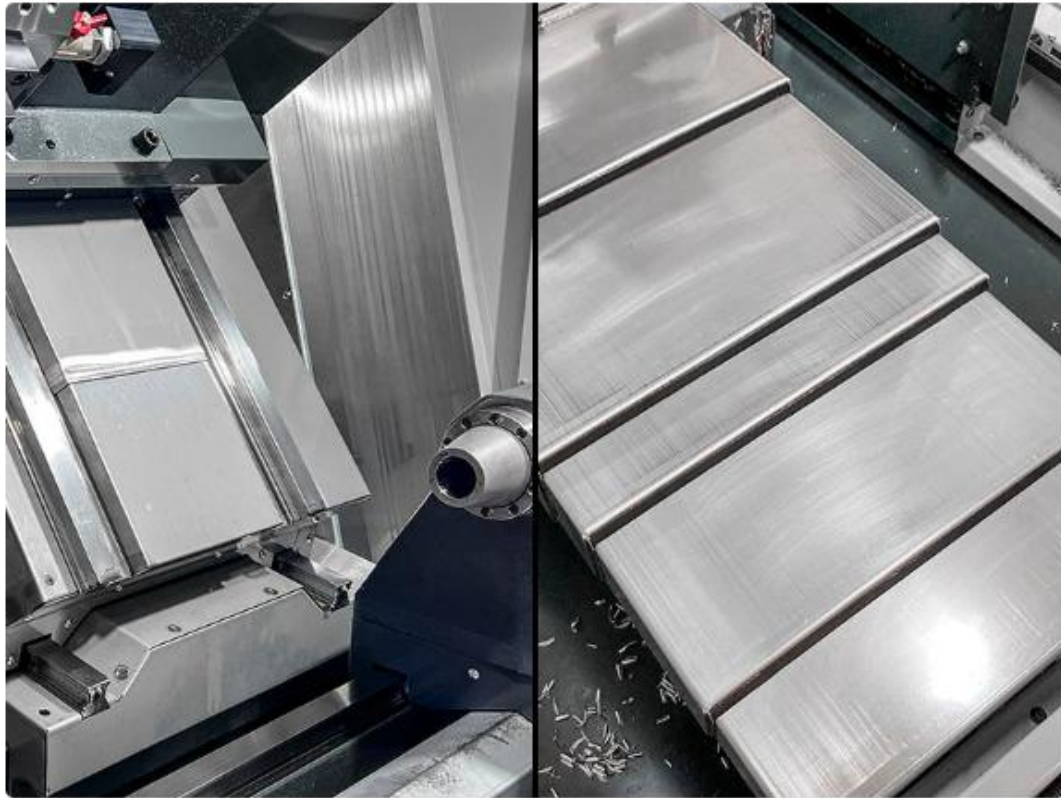

# Products and Price List Update

- MULTI-STAGE CLT PUMP added as standard on all ST-30/35, DS, SB in all regions



## Multi-Stage Coolant Pump

*Standard on some models*

More flow, more pressure, less noise



OPTION INFO



OVERVIEW



SERVICE DOCUMENTS

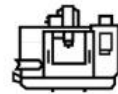

AVAILABLE ON THESE MACHINES





# Products and Price List Update

- Add 2ND PALLET RACK option to RPL-25KG in all regions

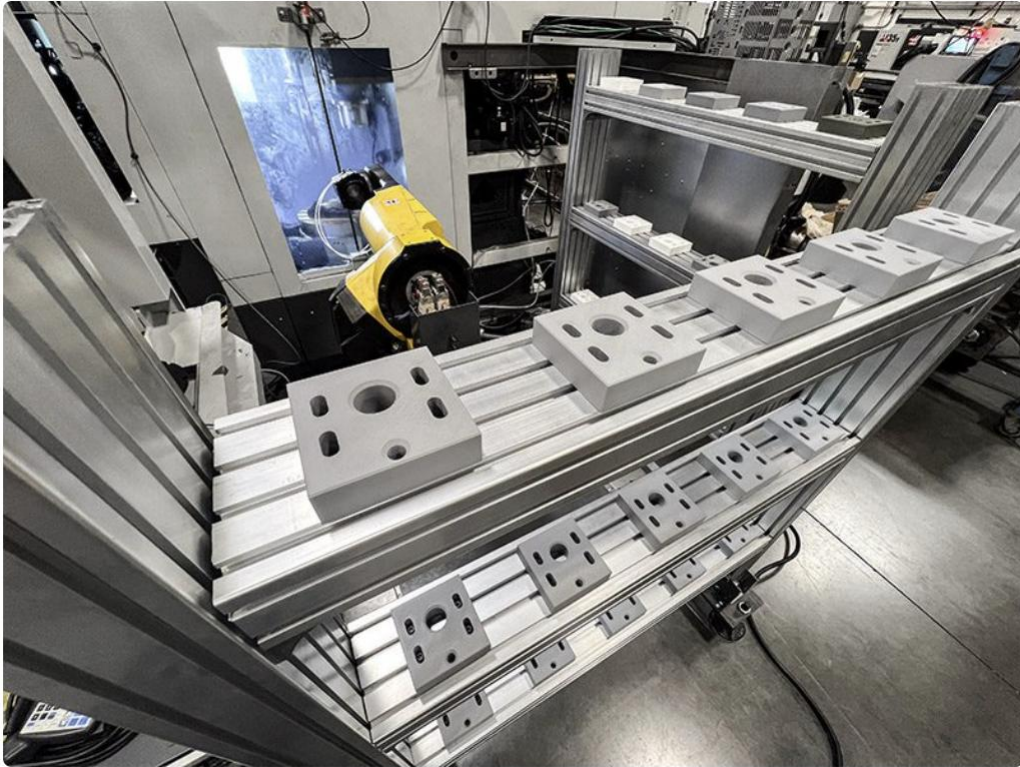

## 2nd Pallet Rack, RPL

**Starting Price: US\$4,995**

Additional capacity and run time

- ✓ Includes 3 zero point pallets and pallet holders
- ✓ Doubles the capacity of the pallet loading system
- ✓ Use for high-mix/low-volume machining, or high-volume production
- ✓ Increases run time for lights-out operation



# Products and Price List Update

- Change MPAL-630 and PAL-630 prices to \$3,995

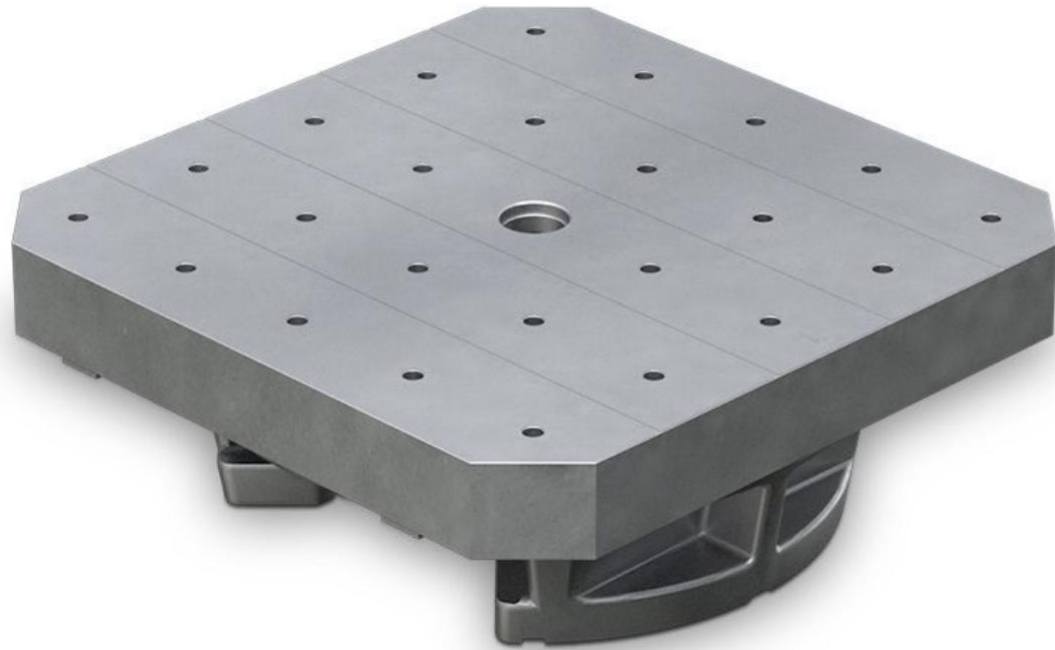

## EC-630 Pallet Kit, Inch

*Standard on some models* \$3,995

Standard pallet kit with inch hole pattern

# Products and Price List Update

- Expand LT350 release to all regions



**•7.87" (200 mm) diameter through-hole**

## LT350 Large-Through-Hole Rotary

**Starting Price: US\$27,695**



- 7.87" (200 mm) diameter through-hole
- Optional platters and chucks available
- Add large-bore 4-axis capabilities
- Easy plug-and-play connection

Our LT Series of rotary tables provide the same features and benefits as our standard HRT Series, but offer large through-bores and a variety of platter and chuck options to handle large shafts, drill pipe, and other large-bore work.

**Note:** Requires a Haas mill with 4th-axis drive and **NGC software version 100.21.000.1130** or later for full 4th-axis operation. Stand-alone operation requires a Haas rotary control box shipped after **November 10, 2021, with software version 26.38 or newer.**

1  
SPINDLES

350 mm  
PLATTER SIZE

348 ft-lb  
MAX TORQUE

156 °/sec  
MAX SPEED

# Products and Price List Update

- Add CBT-30 FRNT LRG UMC option to COBOT PKG-30KG in all regions



## Cobot 30 Front Door Integration Kit, Large UMCs

*Standard on some models*

Load parts through the front door

**For installation on these machines:** UMC-750/SS and UMC-1000/SS

**Front door integration may limit operator access to the front of the machine.**

**Note: Includes Remote Jog Handle and Auto Door when ordered with a machine. Actual kit contents may differ.**

- ✓ Electrical interface box
- ✓ Remote jog handle remote mount (if needed)
- ✓ Door open confirmation switch
- ✓ Dual solenoid kit
- ✓ Spring pusher



# Products and Price List Update

- Change COORD from optional to standard on SR-3015 and SR-4020 in all regions
- Change SO & COORD from optional to standard on SR-3015P & SR-4020P in all regions

## Coordinate Rotation and Scaling

*Standard on some models*

Scale down the number of programs

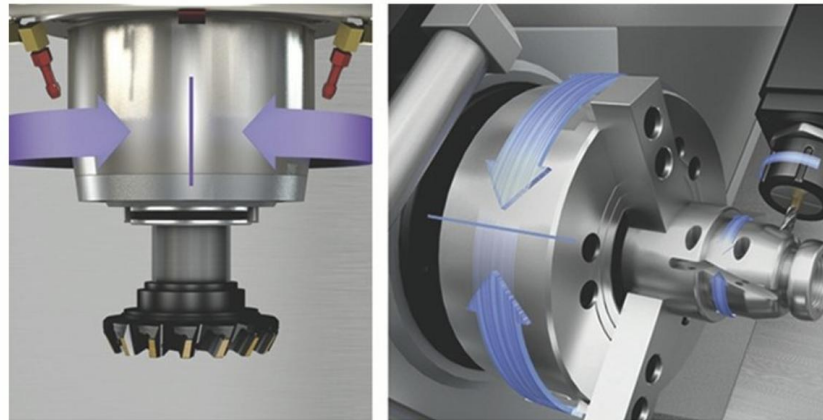
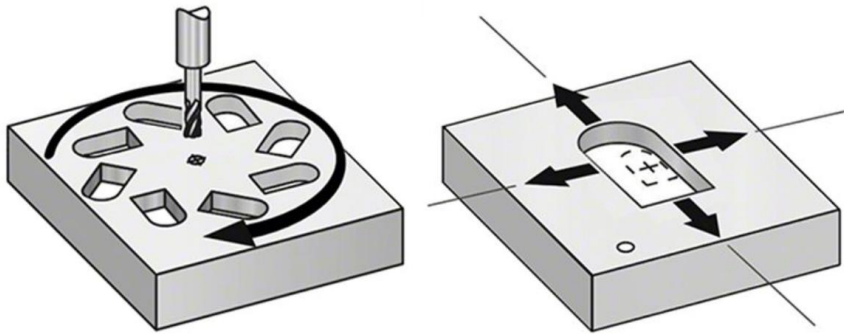

## Spindle Orientation

*Standard on some models*

Simple, repeatable spindle positioning



# Products and Price List Update

- UMC-400:
  - Add 8.1K-40T-IN-15 as standard
  - Change 10K-40T-IN-15 from standard to optional



Inline Drive

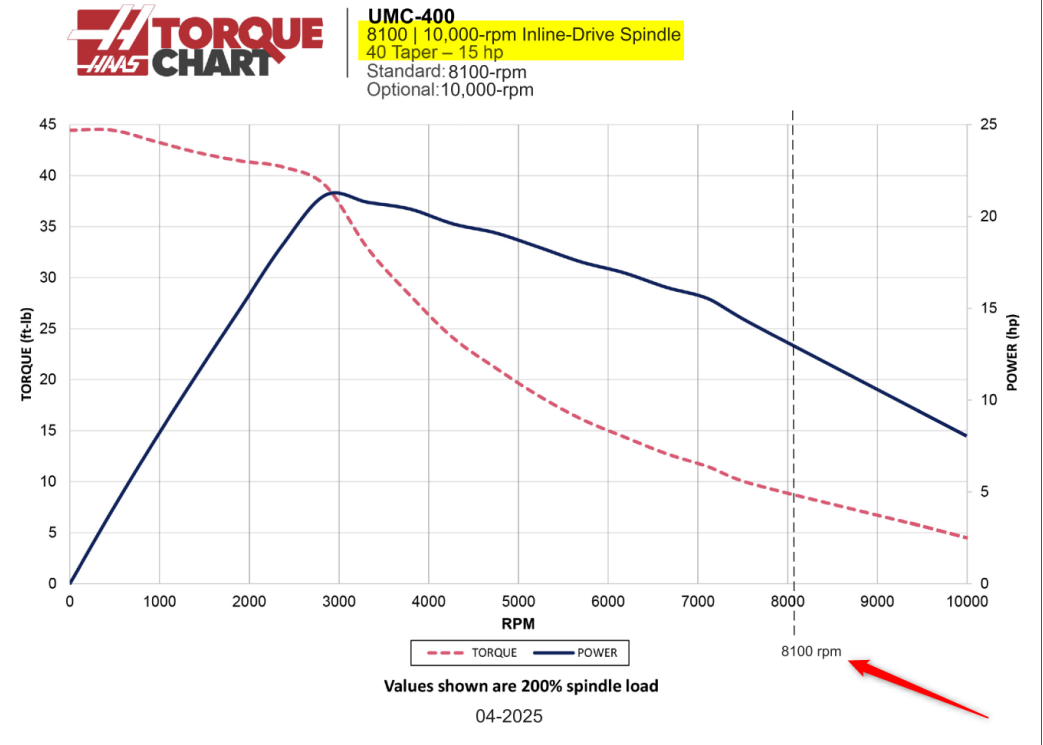

# Products and Price List Update

- Remove HFL-3015, HSG-3063, VF-2-I, VF-2SS-I, VF-2YT-I, VF-2SSYT-I, VF-4-I, VF-4SS-I, VF-5/40-I, VF-5SS-I from all price lists



**HFL-3015 Fiber Laser**



**HSG-3063 Surface Grinder**

The Haas HSG-3063 fully automatic surface grinder provides precision ground surfaces to critical sizes and finishes. Includes an 8" (200 mm) diameter grinding wheel and a 12" x 25" (300 x 600 mm) electromagnetic chuck.

- High-speed 1450-rpm spindle
- Automatic X-, Y-, and Z-axis feed
- Rapid Z-axis feed for quick height set up
- Automatic rough, finish, and spark-out cycles
- Automatic central lube system

**NOTE: Requires 21 gallons (80 L) ISO32 hydraulic oil (not included).**

\* I Models, use whatever PC codes and/or SPRs to put together deals

# Products and Price List Update

- Expand UMC-400/400SS release to all regions



## UMC-400

**Starting Price: US\$104,995**

The UMC-400 has a compact footprint and generous travels that make it the perfect fit for smaller shops, or shops doing 5-axis small-part machining.

Using the proven design elements of our existing UMCs, the UMC-400 is sure to be a great performer. Standard features include a 10,000 rpm 40-taper spindle and a 30+1 side-mount tool changer. All this fits into a compact 7 ft x 7 ft (2.1 x 2.1 meter). That's 25% smaller than the ever-popular UMC-500.

- 5-axis simultaneous machining
- Powerful inline direct-drive spindle
- 30+1 side-mount tool changer
- Includes Wireless Intuitive Probing System

**Current Lead Time** [↗](#)

8 Weeks - Contact your local HFO for delivery tim

40  
TAPER

5  
AXIS

8.1k  
RPM



## UMC-400SS

**Starting Price: US\$125,995**



- 5-axis simultaneous machining
- Powerful inline direct-drive spindle
- High-speed 30+1 side-mount tool changer
- Includes Wireless Intuitive Probing System

The UMC-400SS has a compact footprint and generous travels that make it the perfect fit for smaller shops, or shops doing 5-axis small-part machining.

Using the proven design elements of our existing UMCs, the UMC-400SS is sure to be a great performer. Standard features include a 12,000 rpm 40-taper spindle, 1200-ipm (30.5m/min) rapids, and a high-speed 30+1 side-mount tool changer. All this fits into a compact 7 ft x 7 ft (2.1 x 2.1 meter). That's 25% smaller than the ever-popular UMC-500.

**Current Lead Time** [↗](#)

8 Weeks - Contact your local HFO for delivery times.

40  
TAPER

5  
AXIS

12k  
RPM

30+1  
TOOL CAPACITY

# Products and Price List Update

- Add WIDESCREEN MONITOR as standard on UMC-1000/1250/1500, LG VMC, ST-10/20/40 in all regions



## Control Widescreen Monitor

*Standard on some models*

Larger viewing area with touchscreen control



# Video Update

# Video Update

## Recently Released Videos

- Adaptable Modular Fixturing - Rail Fixture Kits on HaasTooling.com - Haas Automation, Inc. - <https://www.youtube.com/watch?v=zKInRIZaQUU>
- Keep Your Toolholders Clean and Smooth - Electric Toolholder Taper Cleaner at HaasTooling.com - <https://www.youtube.com/watch?v=ka3Ji5OxtCg>

# Video Update

## Recently Released Videos

- Adaptable Modular Fixturing - Rail Fixture Kits on HaasTooling.com - Haas Automation, Inc. - <https://www.youtube.com/watch?v=zKlnRIZaQUU>

### Haas Tooling Video

- Fixture Rails
- Adaptable & Modular
- Great Instructional Video
- Very Informative
- Check it out
- Share it as needed



# Video Update

## Recently Released Videos

- Keep Your Toolholders Clean and Smooth - Electric Toolholder Taper Cleaner at HaasTooling.com - <https://www.youtube.com/watch?v=ka3Ji5OxtCg>

### Haas Tooling Video

- Increase Toolholder life
- Protect the machine spindle
- Increase Tool Life
- Improve Part Accuracy
- Check it out
- Share it





# Tooling Update

# MAY SALE



HAAS TOOLING.COM ONE WEEK ONLY!

UP TO **30% OFF!**

FREE NEXT-DAY DELIVERY FOR 1 YEAR

Sign up for **\$10** (Reg. \$95) WINNER'S CIRCLE

## WINNER'S CIRCLE Update

Still On Sale - Only \$10 – 90% off the already reduced price

Over 10,000 Subscriptions and Growing

# Tooling Update, Global Except Europe & China

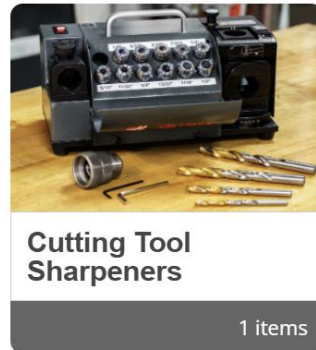
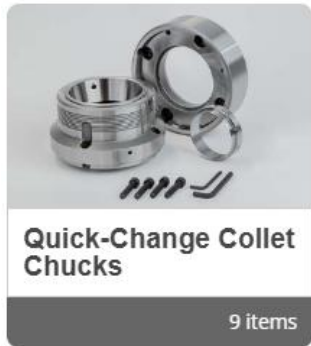

**+63 Items**

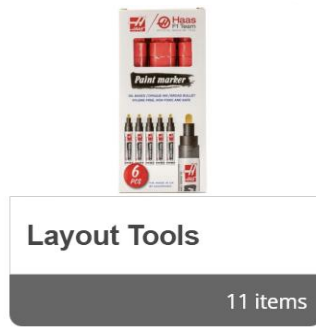
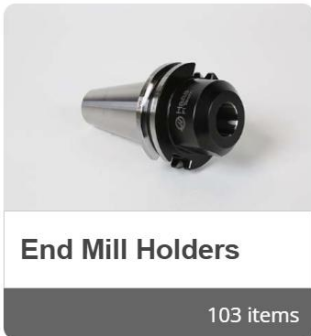

- Lathe Collet Chuck Kits
- Drill Bit Sharpener
- Barfeeder Liners New Design Kits
- Mill Toolholders
- Paint Pens

**UP TO 30% Off!**  
2700+ Tools on Sale!  
HAAS TOOLING.COM

**FREE EXPRESS DELIVERY FOR 1-YEAR**  
Sign up for **WINNER'S CIRCLE**  
**10€**  
(~~95€~~)

## WINNER'S CIRCLE Update

Still On Sale - Only €10 – 90% off the already reduced price

Over 10,000 Subscriptions and Growing



# HAE - Tooling Update



Quick-Change Collet Chucks

17 items



Machine Accessories

2 items



ER Collet Chucks

55 items



Layout Tools

7 items

**+24 Items**

- Lathe Collet Chuck Kits
- Carbon Fiber Bezel, Screen Cover
- Mill Toolholders
- Machinist Pocket Scale

# Marketing Update

## Automation

Easy, Affordable, and Versatile

Learn More

HAAS TOOLING.COM

UP TO **30% OFF!**  
**ONE WEEK ONLY!**

**FREE NEXT-DAY DELIVERY FOR 1 YEAR**  
Get Up To **8% Off** Every Tooling Purchase!

Sign up for **WINNER'S CIRCLE** **\$10**  
(Reg. \$95)

SHOP HAAS TOOLING



# Marketing Update



## LOOKING FOR HOT DEALS ON IN-STOCK MACHINES?

Don't miss out on our Haas CNC machine deals!  
All discounted, in stock, and ready to go!  
Featuring our Demo, Pre-Owned, and Hot List machines.

 [SEE MACHINE DEALS](#)

# 5% to 26% Off!

## STOCK SALE

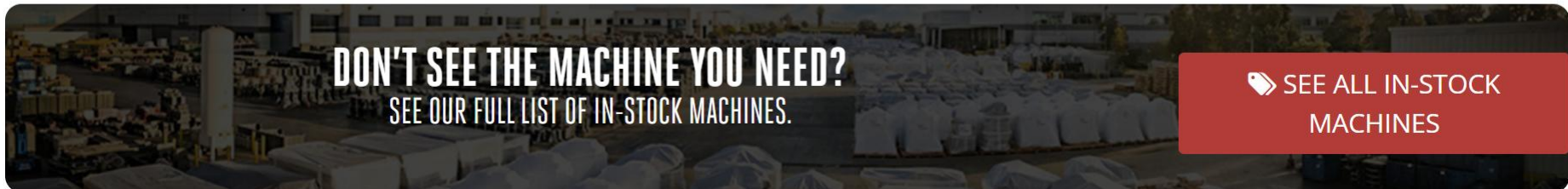
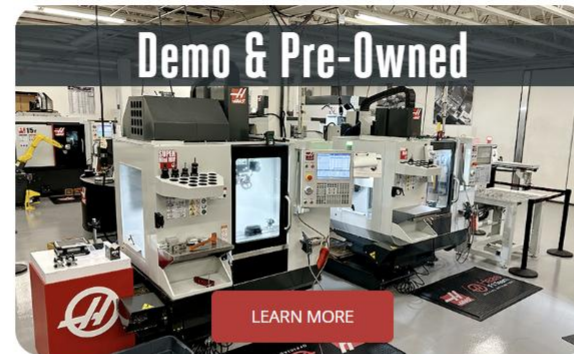



## INSANE FINANCING FOR YOUR NEXT HAAS CNC

DOWN PAYMENT	CHOOSE YOUR TERM						
	12-MONTHS	24-MONTHS	36-MONTHS	48-MONTHS	60-MONTHS	72-MONTHS	84-MONTHS
10% DOWN	0.00%	0.99%	1.99%	2.99%	3.49%	N/A	N/A
20% DOWN	0.00%	0.00%	0.99%	1.49%	2.99%	3.99%	4.49%
25% DOWN	0.00%	0.00%	0.00%	0.99%	1.99%	3.49%	3.99%
30% DOWN	0.00%	0.00%	0.00%	0.00%	1.49%	2.99%	3.49%
20% DOWN + 3-MO SKIP	0.00%	0.49%	0.99%	2.49%	3.99%	4.49%	4.99%

APPLY FOR FINANCING TODAY

\* Financing Terms, Conditions, and Exceptions: References are to an implied interest rate under a conditional sales contract. Interest accrues during the skip period. Down payment, rate, and terms of financing are dependent upon credit approval. Eligible businesses should have three or more years of operation under current ownership. **U.S. and Canada only.**  
 All programs are 10% - 30% down. Must put a minimum of 20% down to get no payments for 3 months.  
**Certain equipment (e.g., stand-alone Rotaries, Shop Equipment, Bar Feeders, etc.) are subject to different rates, terms, and down-payment requirements, unless financed with a machine.** No prepayment penalty on any program. Not responsible for misprints or typographical errors. **Offer valid on new machine orders placed from May 1 through May 31, 2025.**

## Marketing Tools

View Edit Track Devel

\*\*\* All images are clickable \*\*\*



**MARKETING CAMPAIGNS**

[HAAS TOOLING HOME PAGE](#)

[Haas Tooling Promo page](#)

[How to redeem Online Tooling Promos](#)

[2025 AVAILABLE DIGITAL MARKETING CAMPAIGNS and MODEL GUIDES, PDFs, CATALOGS](#)

\*Check Marketing Campaign page for info about HFO Demo Day.

[Tooling Kits Explained \(08/PCK/EK\)](#)

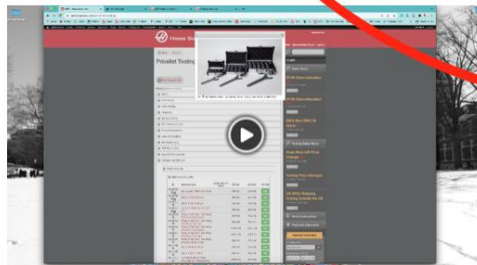

## HFO DEMO DAY \*2025!

### DEMO DAY 2025 THEME: "More Than..."

We are promoting this upcoming Demo Day with the theme of: **"More Than..."**

- ✔ More than CNC, ✔ More than Tooling, ✔ More than Workholding,
- ✔ More than Shop Support, ✔ More than Robots, ✔ More than Automation,
- ✔ More than Rotary, ✔ More than...

HFOs will be presenting these "More than..." topics, but they can choose which specific machines and Haas Tooling items to display that best suit their markets and customers. Customers should walk away from Demo Day with a clear understanding that Haas and their HFO are about more than just machines and are their supplier of choice for all their machine shop needs.

#### Updated Graphics coming soon!

Fill out the survey below to start the process of getting marketing materials created for your Demo Day. You must submit the survey a minimum of 2 months before your event. *(If you have a non-Demo Day event, please fill out the survey for HFO EVENTS.)*

Date updated: Jan 2025

[DEMO DAY SURVEY](#)

[LANDING PAGE TEMPLATE](#)

A survey will be created to collect T-shirt orders. If your Demo Day is scheduled before the survey is available, please email [HFOEmailSupport@HaasCNC.com](mailto:HFOEmailSupport@HaasCNC.com).

#### Email ↓



# Marketing Campaign Update

## 2025 AVAILABLE DIGITAL MARKETING CAMPAIGNS + MODEL GUIDES/PDFS/CATALOGS

These campaigns will be running throughout 2025. Email [HFOEmailSupport@haascnc.com](mailto:HFOEmailSupport@haascnc.com) if you want to have Haas email your customer base regarding any of the below campaigns.

### CURRENT LIVE MARKETING CAMPAIGNS

#### NEW Marketing Campaigns added

- **Box Way Lathe \*NEW**
- **HFL-3015 Fiber Laser \*NEW**
- **DMs/DTs \*NEW**
- **Hot Deals on In-Stock Machines \*NEW**
- **Financing Rates \*NEW**
- **SR-3015 Sheet Router \*NEW**
- **HFO Demo Day \*NEW**
- **DC-Series \*NEW**
- **GM-1 Gantry Mills \*NEW**

#### Ongoing Marketing Campaigns Available

- EU Models *(update coming soon)*
- Mini Mill Redesign

- Haas Makes It Easy
- Why Haas
- First-Time Buyers
- Small Footprint
- Affordable Machines
- Most Popular Machines

### TOOLING MARKETING CAMPAIGNS

- **Haas Cobot \*NEW**
- Benefits of Haas Tooling
- Haas Workholding by Kurt
- Ready2Run
- Ready2Machine

PROMOTIONS

NEW PRODUCTS

GENERAL & MACHINE

TOOLING

PDFS AND BROCHURES

## NEW PRODUCT MARKETING CAMPAIGNS

- ✓ Band Saw
- ✓ Air Compressor
- ✓ Laser Marker
- ✓ CMM
- ✓ Surface Grinder

- ✓ Knee Mill
- ✓ UMC-400/SS
- ✓ DMs/DTs
- ✓ TL-P
- ✓ ST-40 Updates (short/long/Y-axis)

- ✓ DC Series
- ✓ SB Series
- ✓ SR-3015 and SR-3015P Sheet Router
- ✓ Robotic Pallet Loader
- ✓ Mini Max
- ✓ HFL-3015 Fiber Laser
- ✓ GM-1 Series

**\*More New Machines Coming Soon!**



# HAE Marketing Update

## Automation

Easy, Affordable, and Versatile



Learn More



HAAS TOOLING.COM 2700+ tools on sale!

UP TO **30% Off!**

**FREE EXPRESS DELIVERY FOR 1 YEAR** Sign up for WINNER'S CIRCLE **10€** (95€)

+ Get Up To **8% Off** Every Tooling Purchase!

SHOP HAAS TOOLING

Machines Configured Exclusively for Europe

## EU SERIES: UP TO 34% OFF

MORE CHOICES, MORE VALUE – JUST FOR EUROPE

LEARN MORE

- 

Build-&-Price  
Learn More >
- 

In-Stock Machines  
Learn More >
- 

Unbeatable Financing  
Learn More >
- 

What's New?  
Learn More >



# HAE Marketing Update



## LOOKING FOR HOT DEALS ON IN-STOCK MACHINES?

Don't miss out on our Haas CNC machine deals!  
All discounted, in stock, and ready to go!  
Featuring our Demo, Pre-Owned, and Hot List machines.

[SEE MACHINE DEALS](#)

# 5% to 35% Off!

## STOCK SALE

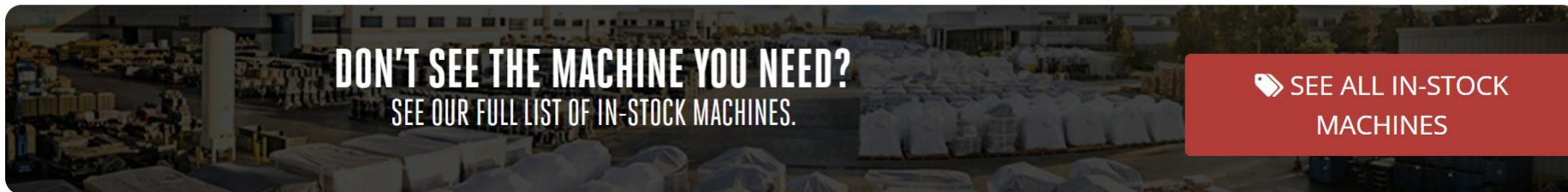
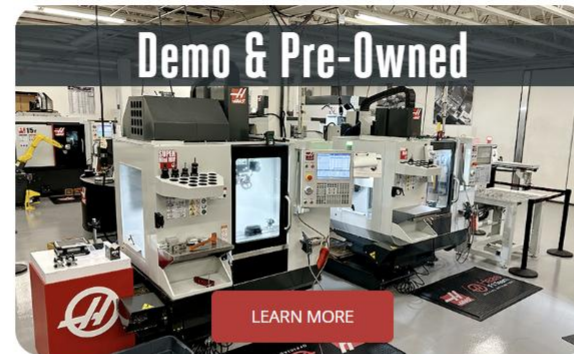

# HAE Marketing Update

## CHOOSE YOUR FINANCING

**NO MODEL  
RESTRICTIONS**

**UP TO 3-MONTH SKIP  
AVAILABLE**

**NO PRE-PAYMENT  
PENALTIES EVER!**

LOWEST DOWN PAYMENT  
**10% DOWN**

3,49% Interest for as Long as 60-Months.

Payments as Low as  
**€1.637 PER MONTH**

LOWEST INTEREST  
**0% FOR 48 MONTHS**

Requires Larger Down Payment.

Payments as Low as  
**€1.458 PER MONTH**

LONGEST TERM  
**84-MONTH TERM**

With Rates as Low as 3,49%\*

Payments as Low as  
**€940 PER MONTH**

Sample payments are based on a €100.000 CNC machine purchase.

**SAVE €9.845 IN INTEREST!**

(Based on 0,00% for 48 months, compared to lenders with similar terms at 6,66% interest.)

## INSANE FINANCING FOR YOUR NEXT HAAS CNC

DOWN PAYMENT	CHOOSE YOUR TERM						
	12-MONTHS	24-MONTHS	36-MONTHS	48-MONTHS	60-MONTHS	72-MONTHS	84-MONTHS
10% DOWN	0,00%	0,99%	1,99%	2,99%	3,49%	N/A	N/A
20% DOWN	0,00%	0,00%	0,99%	1,49%	2,99%	3,99%	4,49%
25% DOWN	0,00%	0,00%	0,00%	0,99%	1,99%	3,49%	3,99%
30% DOWN	0,00%	0,00%	0,00%	0,00%	1,49%	2,99%	3,49%
20% DOWN + 3-MO SKIP	0,00%	0,49%	0,99%	2,49%	3,99%	4,49%	4,99%

\*Financing terms, conditions, and exceptions: valid in Denmark, Germany, France, Spain, Portugal, Belgium, Luxembourg, Estonia, Latvia, Lithuania, Czech Republic, Slovenia, Slovakia, and Greece only. References are to an implied interest rate under a conditional sales contract. Interest accrues during the skip period. Down payment, rate, and terms of financing are dependent upon credit approval. Eligible businesses should have three or more years of operation under current ownership. All programs are 10% - 30% down. Must put a minimum of 20% down to get no payments for 3 months. **Certain equipment (e.g., stand-alone Rotaries, Shop Equipment, Bar Feeders, etc.) are subject to different rates, terms, and down-payment requirements, unless financed with a machine.** No prepayment penalty on any program.

Offer valid on new machine orders placed from 1 May 2025 through 31 May 2025.

# Did You Know...



# Did You Know...

## Tooling Plate Table vs. T-Slot Table for VS & HDC

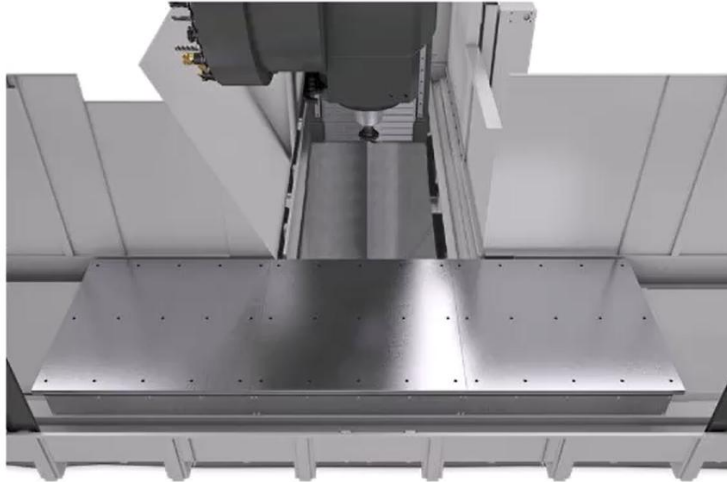

### Tooling Plate Table

Standard table for VS Series and HDC



### Optional T-Slot Table @ n/c



### T-Slot Table

T-Slot Table: replaces the standard blank tooling plates with T-slot tooling plates.

# Did You Know...

## VS-3

**Starting Price: US\$577,995**

The Haas VS-3 is a large-frame, bed-style machining center that provides large travels and heavy-duty cutting capacity in a vertical spindle format. The machine features a 50-taper, geared-head spindle and a 50+1 tool side-mount tool changer. The fully supported X-axis travels easily handle parts weighing up to 10,000 lb (4536 kg). The table surface consists of three blank tooling plates that are easily machined for custom fixturing.

**NOTE: A T-slot table can be substituted for the tooling plate table at the time of order.**

**HDC-3-5AX**

Price List  Specs  Image  ATP  Machine interface (RMI) and RF probes.  and coordinate rotation & scaling. **Included**

<b>BASE</b>	<b>\$ 999,995</b>	<b>OPTIONS</b>	<b>\$ 0</b>	<b>TOTAL</b>	<b>\$ 999,995</b>
-------------	-------------------	----------------	-------------	--------------	-------------------

**TOOLING PLATE TABLE** **Included**

Table: Blank Tooling Plate Table; can be machined as needed for custom fixtures and workholding.

**SMTC-50-HSK** **Included**

Tool Changer: Side-Mount Tool Changer, HSK taper, 50+1 tools

**HDC-3-5AX**

Price List  Specs  Image  ATP  **\$ 1,295**

<b>BASE</b>	<b>\$ 999,995</b>	<b>OPTIONS</b>	<b>\$ 0</b>	<b>TOTAL</b>	<b>\$ 999,995</b>
-------------	-------------------	----------------	-------------	--------------	-------------------

**Table**

**\*T-SLOT TABLE** **\$ 0**

T-Slot Table; replaces the standard blank tooling plates with T-slot tooling plates.

# Did You Know...

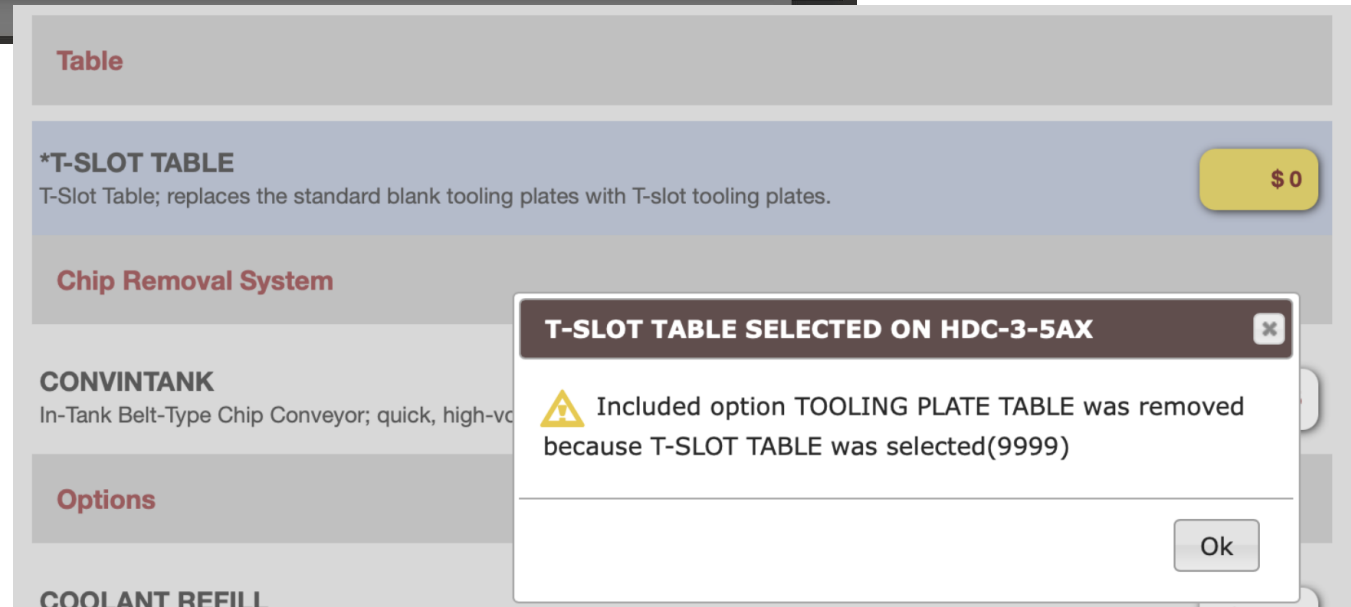
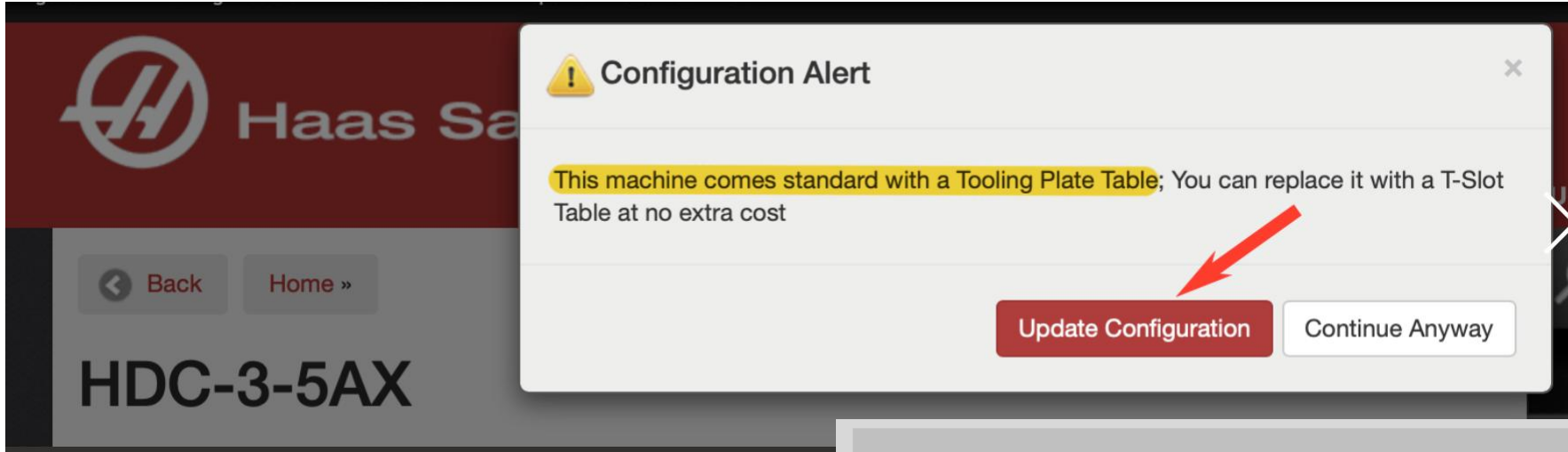

- Factory Training Dates for 2025
  - June 18/19
  - September 10/11
  - December 3/4

Please email Scott Gasich directly with any names, email addresses and job functions for those who will be attending





**THANK YOU!**  
**FOR ALL YOUR EFFORTS**



**HMAS**

