



**SALES AND MARKETING
UPDATE**



HMAS

October 2025



Topics

- Products and Price List
- Video
- Tooling
- Marketing
- Did You Know...

Products and Price List Update

Products and Price List Update

- Pocket Mill price decreased to \$24,995 in all regions.
- Release RPL-30KG for sale in US/Canada/Mexico
- Expand SB-28Y release to all regions.
- COBOT PKG-30KG is now available on DS-30Y with CBT-30 FRNT ST-30-35 in all regions where COBOT PKG-30KG is released.
- COBOT PKG-30KG is now available on all versions of ST-40 and ST-45 with CBT-30 FRNT ST-40-45 in all regions where COBOT PKG-30KG is released.
- ROBOT PKG-1 is no longer available on ST-10L, ST-10LY, ST-15L, ST-15LY, ST-20L, ST-20LY, ST-25L, ST-25LY, ST-28L, ST-28LY, DC-1, DC-1/40, in all regions.
- ROBOT PKG-1 is no longer available for side loading on DC-2, and DC-2/40 in all regions.
- ROBOT PKG-7KG is no longer available on ST-20L, ST-20LY, ST-25L, ST-25LY, ST-28L, ST-28LY in all regions.
- ROBOT PKG-2 is now available on DS-20Y, DS-25Y, and DS-30Y with 20-35 HRP-2 INST in all regions where ROBOT PKG-2 is released.
- ROBOT PKG-25KG is now available on DS-20Y, DS-25Y, and DS-30Y with 20-35 HRP-25 INST in all regions where ROBOT PKG-25KG is released.
- ROBOT PKG-3 is now available on UMC-1250/50 with UMC-1250 HRP3 SIDE in all regions where ROBOT PKG-3 is released.
- ROBOT PKG-3 is no longer available on VF-5/40TR, VF-5/50TR, VF-6/40TR, and VF-6/50TR in all regions.
- ROBOT PKG-50KG is now available on UMC-1250/50 with UMC-1250 HRP-50 SIDE in all regions where ROBOT PKG-50KG is released.
- ROBOT PKG-50KG is no longer available on VF-5/40TR, VF-5/50TR, VF-6/40TR, and VF-6/50TR in all regions.
- CABCOOL changed from optional to a standard on ST-40SY, ST-45SY, ST-40Y, ST-45Y, ST-40LY, ST-45LY in all regions
- Remove BMT65-24-NLT from being an available option on SB-28, SB-35, SB-35L in all regions.
- 40GAL replaces 55GAL as a standard feature on SB-28 and SB-28Y in all regions.
- 100GAL replaces 55GAL as a standard feature on SB-35, SB-35Y, SB-35L, SB-35LY in all regions.
- 2.5K-40HP-A2-8 replaces 3.2K-40HP-A2-8 as a standard feature on SB-35, SB-35Y, SB-35L, SB-35LY in all regions.
- Release HFL-3015-3 for sale in US/Canada/Mexico. HFL-3015-3 replaces HFL-3015.
- Release HFL-3015-6 for sale in US/Canada/Mexico.
- Remove VARIABLE FLOW CLNT as an available option on GM-2-5AX in all regions.
- Add HIGH PRESSURE COOL as an available option on GM-2-5AX in all regions.
- Release COBOT PKG-20KG-F for sale in all regions.
- Release HAB-3232-CE for sale in HE and CH.
- Add 12K-40T-GREASE-IN as an option on VF-3SS, 3SSYT, 4SS, 5SS, VM-2, VM-3 in all regions.
- Price Drop on 30K spindle option in all regions.

Products and Price List Update

- Pocket Mill price decreased to \$24,995 in all regions.



Pocket Mill

Starting Price: **US\$24,995**



- Full-function, easy-to-use Haas control
- Standard 40-taper spindle
- Available 10-pocket tool changer
- Single- or 3-phase power

The Haas Pocket Mill is small enough to fit into nearly any pocket of space in your shop, while providing the features and performance of our full-size machines, at a very affordable price.

It's the perfect choice for start-up shops, schools, hobbyists, garage machinists, or anyone with limited space and a limited budget.

Current Lead Time 

1 Weeks - Contact your local HFO for delivery times.

Products and Price List Update

- Release RPL-30KG for sale in US/Canada/Mexico



30 kg **Robotic** Pallet Loading System

Starting Price: US\$120,295

The Haas RPL-30KG Robotic Pallet Loading System includes the Haas 30 kg capacity robot, loading station, light curtain, pallet rack, and 3 zero point pallets (expandable to 15 pallets). Includes the Zero Point Ready option, auto window, and remote jog handle when purchased with a machine. Requires the Zero Point Ready option, auto window, and remote jog handle when purchased separately.

- All-inclusive design
- Plug-and-play capabilities to UMCs and VMCs
- Set up and operated via the Haas control
- Includes load station, rack, and 3 pallets
- Expandable to 15 pallets
- Expandable to 30 pallets w/optional 2nd pallet rack

NOTE: The zero point system requires a minimum of 100 psi (6.9 bar) air pressure from the machine.

Haas Robots carry a full two-year warranty.

ADDITIONAL PALLETS AND EXPANSION KITS AVAILABLE AT HAASTOOLING.COM

30 kg Robotic Pallet Loading System Build-to-Price

Base Price **US\$120,295** Payments as low as **US\$2,043/mo** 60 months

Current Configuration >

CURRENT CONFIGURATION

The Haas Control
Product Options
Workholding
Installation Kits

The Haas Control	Standard	Remote E-Stop
Product Options	Standard	2-Meter Light Curtain Kit
	Standard	Zero Point Ready
Workholding	Standard	Zero Point Pallet Kit, RPL-30KG

* We've turned off the "cobotness,"
 So it functions as an industrial robot.

Products and Price List Update

- Expand SB-28Y release to all regions.



SB-28Y Box Way Lathe

Starting Price: **US\$136,995**



- BMT65 turret
- Hardened and precision ground ways
- Hand-scraped Turcite-B slideways
- 30° slant-bed with 30° Y-axis wedge angle
- Compact footprint

The Haas SB-28Y offers the high dynamic stiffness, load-bearing capacity, and vibration damping associated with traditional box way machines, combined with the powerful, easy-to-use Haas control, and backed by the industry-leading support of the Haas Factory Outlet network.

NOTE: The SB-28Y is not compatible with the Haas Bar Feeder, and is not available with a parts catcher.

10"
CHUCK SIZE

2.9"
BAR CAPACITY

3200
RPM

40 hp
POWER

[COMPARE MACHINES](#)

[EXPLORE ALL INVENTORY](#)

Available for order in the U.S., Canada, Mexico, and Europe, with estimated delivery Q3 2025.

Products and Price List Update

- COBOT PKG-30KG is now available on DS-30Y with CBT-30 FRNT ST-30-35 in all regions where COBOT PKG-30KG is released.

DS-30Y Build-&-Price

Base Price **US\$174,995** Payments as low as **US\$3,038/mo** 60 months ▾

Current Configuration

Value Option Packages

Spindles

Turrets & Live Tooling

Probing



Chip & Coolant Management

The Haas Control

Product Options

AUTOMATION

Cobots

	HAAS 10 KG COBOT PACKAGE US\$781/mo US\$44,995 DETAILS >		HAAS 15 KG COBOT PACKAGE US\$1,041/mo US\$59,995 DETAILS >
	HAAS 30 KG COBOT PACKAGE US\$1,215/mo US\$69,995 DETAILS >		

Products and Price List Update

- COBOT PKG-30KG is now available on all versions of ST-40 and ST-45 with CBT-30 FRNT ST-40-45 in all regions where COBOT PKG-30KG is released.

ST-40 Build-&-Price

Base Price **US\$166,995** Payments as low as **US\$2,899/mo** 60 months ▾

Current Configuration

Spindles

Turrets & Live Tooling

Probing

Chip & Coolant Management

The Haas Control

Product Options

AUTOMATION

Cobots

	HAAS 30 KG COBOT PACKAGE	US\$1,215/mo
	DETAILS >	US\$69,995 +

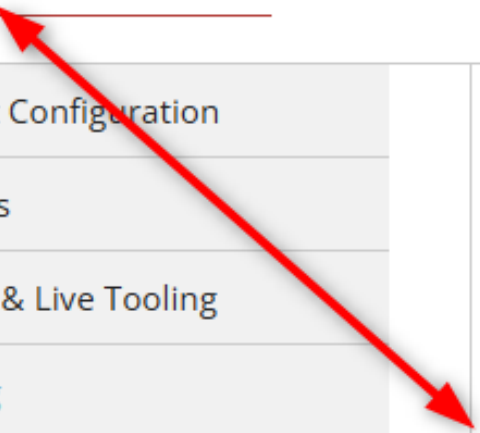

Products and Price List Update

- ROBOT PKG-1 is no longer available on ST-10L, ST-10LY, ST-15L, ST-15LY, ST-20L, ST-20LY, ST-25L, ST-25LY, ST-28L, ST-28LY, DC-1, DC-1/40, in all regions.



~~Haas Robot Package 1~~

~~**Starting Price: 47.995 €**~~

~~The Haas Robot Package 1 is a fully integrated, plug-and-play, 7 kg capacity robot system for Haas machines. The system is controlled entirely from the Haas control. Includes: 6-axis robot, mounting stand, software interface for direct control through the Haas machine, electrical interface box, safety guarding, and all necessary solenoids, hardware, and cables.~~

~~7 kg Max Capacity (part + gripper)~~

- ~~• All-inclusive design, with plug-and-play capabilities to Haas small vertical machining centers, DT/DM series, UMC-350HD, UMC-500, and ST-10 through ST-28 turning centers~~
- ~~• Interfaces directly with the Haas control~~
- ~~• All set up and operation is done through the Haas control and remote jog handle~~
- ~~• Single gripper included; double gripper available~~
- ~~• 7 kg capacity at wrist (part + gripper)~~
- ~~• Includes CE compliant safety guard fencing~~
- ~~• No need for additional M-code outputs, or the complex PLC connections used by 3rd-party integrators~~

~~**Haas Robots carry a full two-year warranty.**~~

Products and Price List Update

- ROBOT PKG-1 is no longer available for **side loading** on DC-2, and DC-2/40 in all regions.

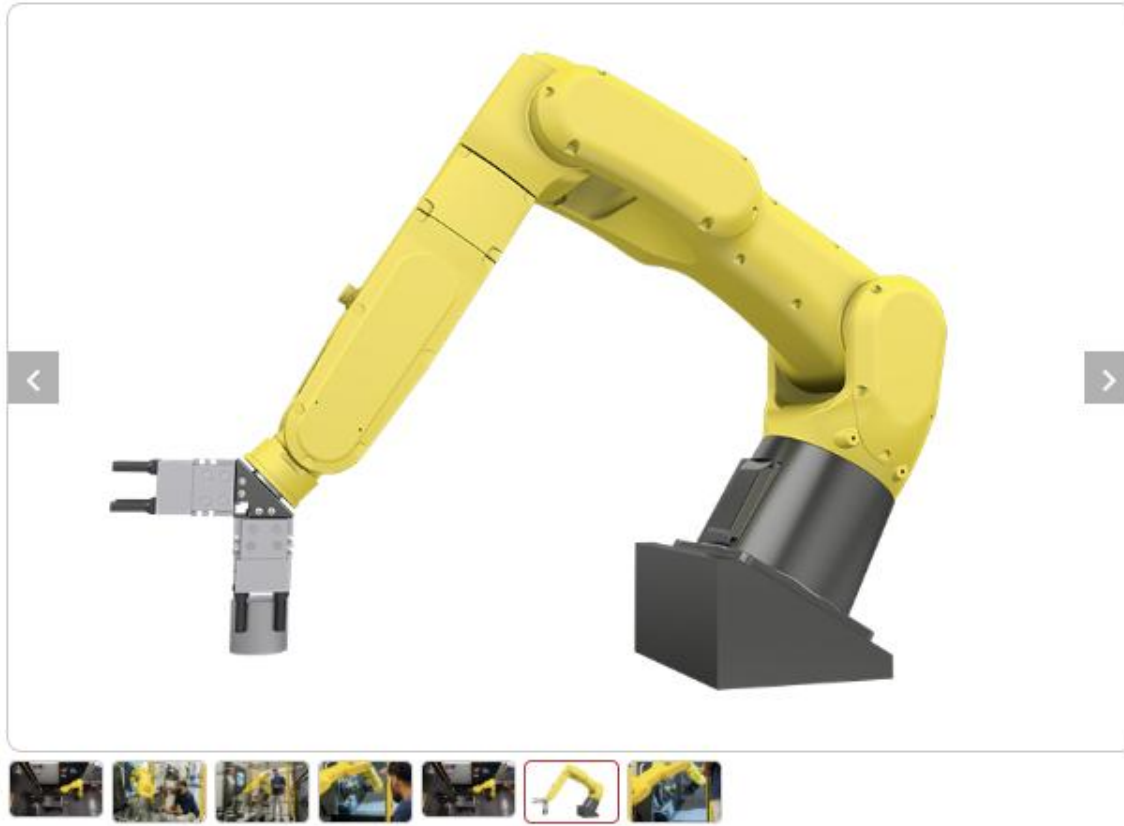

~~Haas Robot Package 1~~

~~**Starting Price. 47.995 €**~~

~~The Haas Robot Package 1 is a fully integrated, plug-and-play, 7 kg capacity robot system for Haas machines. The system is controlled entirely from the Haas control. Includes: 6-axis robot, mounting stand, software interface for direct control through the Haas machine, electrical interface box, safety guarding, and all necessary solenoids, hardware, and cables.~~

~~7 kg Max Capacity (part + gripper)~~

- ~~• All-inclusive design, with plug-and-play capabilities to Haas small vertical machining centers, DT/DM series, UMC-350HD, UMC-500, and ST-10 through ST-28 turning centers~~
- ~~• Interfaces directly with the Haas control~~
- ~~• All set up and operation is done through the Haas control and remote jog handle~~
- ~~• Single gripper included; double gripper available~~
- ~~• 7 kg capacity at wrist (part + gripper)~~
- ~~• Includes CE compliant safety guard fencing~~
- ~~• No need for additional M-code outputs, or the complex PLC connections used by 3rd-party integrators~~

~~**Haas Robots carry a full two-year warranty.**~~

* Same applies to Robot PKG-7kg

Products and Price List Update

- ROBOT PKG-7KG is no longer available on ST-20L, ST-20LY, ST-25L, ST-25LY, ST-28L, ST-28LY in all regions.



~~Haas 7 kg Robot Package~~

~~**Starting Price. US\$49,695**~~

~~The Haas Robot Package 7kg is a fully integrated, plug-and-play, 7 kg capacity robot system for Haas machines. The system is controlled entirely from the Haas control. Includes: 6-axis robot, mounting stand, software interface for direct control through the Haas machine, electrical interface box, interface for area scanners or light curtains, and all necessary solenoids, hardware, and cables.~~

~~7 kg Max Capacity (part + gripper)~~

- ~~• All-inclusive design, with plug-and-play capabilities to Haas small vertical machining centers, DT/DM series, UMC-350HD, UMC-400/SS, UMC-500/SS, DC-1, DC-1/40, DC-2, DC-2/40, and ST-10 through ST-28 turning centers~~
- ~~• Interfaces directly with the Haas control~~
- ~~• Includes interface for optional area scanners or light curtains~~
- ~~• All set up and operation is done through the Haas control and remote jog handle~~
- ~~• Single gripper included; double gripper available~~
- ~~• 7 kg capacity at wrist (part + gripper)~~
- ~~• No need for additional M-code outputs, or the complex PLC connections used by 3rd-party integrators~~

~~**Haas Robots carry a full two-year warranty.**~~

Products and Price List Update

- ROBOT PKG-2 is now available on DS-20Y, DS-25Y, and DS-30Y with 20-35 HRP-2 INST in all regions where ROBOT PKG-2 is released.

DS-25Y Build-&Price

Base Price **146.995 €** Payments as low as **1.882 €/mo** 84 months ▾

Current Configuration

Spindles

Turrets & Live Tooling

Probing

Chip & Coolant Management

The Haas Control

Product Options

Tooling & Fixturing

Workholding

Shipping





Warranty

Automation >







HAAS TOOLING

AUTOMATION

Cobots

	HAAS 10 KG COBOT PACKAGE	526 €/mo
DETAILS >	41.095 €	
	HAAS 15 KG COBOT PACKAGE	701 €/mo
DETAILS >	54.795 €	

Robots

	HAAS ROBOT PACKAGE 1	614 €/mo
DETAILS >	47.995 €	
	HAAS ROBOT PACKAGE 2	922 €/mo
DETAILS >	71.995 €	
	HAAS ROBOT PACKAGE 3	1.227 €/mo
DETAILS >	95.895 €	

Products and Price List Update

- ROBOT PKG-25KG is now available on DS-20Y, DS-25Y, and DS-30Y with 20-35 HRP-25 INST in all regions where ROBOT PKG-25KG is released.

DS-25Y Build-&Price Base Price **US\$167,995** Payments as low as **US\$2,916/mo** 60 months ▾

Current Configuration

Value Option Packages

Spindles

Turrets & Live Tooling

Probing

Chip & Coolant Management

The Haas Control

Product Options

Tooling & Fixturing

Workholding



Shipping

Warranty



Automation >

AUTOMATION

Cobots

	HAAS 10 KG COBOT PACKAGE DETAILS >	US\$781/mo US\$44,995	+
	HAAS 15 KG COBOT PACKAGE DETAILS >	US\$1,041/mo US\$59,995	+

Robots



	HAAS 7 KG ROBOT PACKAGE DETAILS >	US\$863/mo US\$49,695	+
	HAAS 25 KG ROBOT PACKAGE DETAILS >	US\$1,340/mo US\$77,195	+
	HAAS 50 KG ROBOT PACKAGE DETAILS >	US\$1,531/mo US\$88,195	+

Products and Price List Update

- ROBOT PKG-3 is now available on UMC-1250/50 with UMC-1250 **HRP3 SIDE** in all regions where ROBOT PKG-3 is released.

UMC-1250/50 Build-&-Price

Base Price **295.995 €** Payments as low as **3.789 €/mo** 84 months ▾

Current Configuration	AUTOMATION
Spindles	
Tool Changers	
Probing	
Chip & Coolant Management	
The Haas Control	
Product Options	Pallet Pools
Tooling & Fixturing	 6+1 PALLET POOL, UMC 1.547€/mo 120.895 € DETAILS > +
Workholding	Robots
Shipping	 HAAS ROBOT PACKAGE 3 1.227€/mo 95.895 € DETAILS > +

Note: A red arrow points from the 'UMC-1250/50' header to the 'HAAS ROBOT PACKAGE 3' option in the Robots section.

Products and Price List Update

- ROBOT PKG-3 is no longer available on VF-5/40TR, VF-5/50TR, VF-6/40TR, and VF-6/50TR in all regions.



~~Haas Robot Package 3~~

Starting Price: 95.895 €

The Haas Robot Package 3 is a fully integrated, plug-and-play, 50 kg capacity robot system for Haas machines. The system is controlled entirely from the Haas control. Includes: 6-axis robot, software interface for direct control through the Haas machine, electrical interface box, safety guarding, and all necessary solenoids, hardware, and cables.

50 kg Max Capacity (part + gripper)

NOTE: Part table not included. The robot must be bolted to the floor, and requires a separate 200-230V 3-Phase, 50/60 Hz, 7.5 kVA power supply.

- All-inclusive design, with plug-and-play capabilities to Haas vertical machining centers and turning centers
- Interfaces directly with the Haas control
- Single gripper included
- 50 kg capacity at wrist (part + gripper)
- Includes CE-compliant safety guard fencing.
- No need for additional M-code outputs, or the complex PLC connections used by 3rd-party integrators
- Requires a separate 200-230V 3-Phase, 50/60 Hz, 7.5 kVA power supply

Haas Robots carry a full two-year warranty.

Products and Price List Update

- ROBOT PKG-50KG is now available on UMC-1250/50 with UMC-1250 **HRP-50 SIDE** in all regions where ROBOT PKG-50KG is released..

UMC-1250/50 Build-&Price

Base Price **US\$339,995** Payments as low as **US\$5,902/mo** 60 months ▾

Current Configuration

Spindles

Tool Changers

Probing

Chip & Coolant Management

The Haas Control

Product Options

Tooling & Fixturing

Workholding

Shipping

Warranty

Automation >

Haas Tooling

AUTOMATION

Pallet Pools

6+1 PALLET POOL, UMC US\$2,413/mo
DETAILS > US\$138,995 +

Cobots

HAAS 30 KG COBOT PACKAGE US\$1,215/mo
DETAILS > US\$69,995 +

Robots

HAAS 50 KG ROBOT PACKAGE US\$1,531/mo
DETAILS > US\$88,195 +

Products and Price List Update

- ROBOT PKG-50KG is no longer available on VF-5/40TR, VF-5/50TR, VF-6/40TR, and VF-6/50TR in all regions.



~~Haas 50 kg Robot Package~~

Starting Price: US\$88,195

The Haas Robot Package-50kg is a fully integrated, plug-and-play, 50 kg capacity robot system for Haas machines. The system is controlled entirely from the Haas control. Includes: 6-axis robot, software interface for direct control through the Haas machine, electrical interface box, interface for optional area scanners or light curtains, and all necessary solenoids, hardware, and cables.

50 kg Max Capacity (part + gripper)

NOTE: Part table not included. The robot must be bolted to the floor, and requires a separate 200-230V 3-Phase, 50/60 Hz, 7.5 kVA power supply.

- All-inclusive design, with plug-and-play capabilities to Haas vertical machining centers and turning centers
- Interfaces directly with the Haas control
- Includes interface for optional area scanners or light curtains
- Single gripper included
- 50 kg capacity at wrist (part + gripper)
- No need for additional M-code outputs, or the complex PLC connections used by 3rd-party integrators
- Requires a separate 200-230V 3-Phase, 50/60 Hz, 7.5 kVA power supply

Haas Robots carry a full two-year warranty.

Products and Price List Update

- CABCOOL changed from optional to a standard on ST-40SY, ST-45SY, ST-40Y, ST-45Y, ST-40LY, ST-45LY in all regions

BUILD-&-PRICE MACHINE INFO DETAILS SPECS

ST-40Y with BMT75 Build-&-Price

Base Price **US\$229,995** Payments as low as **US\$3,992/mo** 60 months ▾

Current Configuration >

Spindles

Turrets & Live Tooling

Probing

Chip & Coolant Management

The Haas Control

Product Options

Tooling & Fixturing

Workholding

Shipping

CURRENT CONFIGURATION

Spindles	Standard	2400-rpm Spindle
Turrets & Live Tooling	Standard	4000-rpm Live Tooling with 12-Station BMT75 Turret and C Axis
Chip & Coolant Management	Standard	95-Gallon Coolant Tank
	Standard	Multi-Stage Coolant Pump
The Haas Control	Standard	Control Widescreen Monitor
	Standard	Large Remote Jog Handle with Touchscreen Display
	Standard	Ethernet Interface
	Standard	WiFi Connection for the Haas Control
	Standard	CNC Control Cabinet Cooler
	Standard	Power Surge Protection
Standard	Early Power-Failure Detection Module	



CNC Control Cabinet Cooler

CNC Control Cabinet Cooler; reduces the internal temperature of the control cabinet to boost reliability and increase component life. No external power required.

Products and Price List Update

- Remove BMT65-24-NLT from being an available option on SB-28, SB-35, SB-35L in all regions.



~~4000-rpm Live Tooling with 24-Station BMT65 Turret and C Axis~~

Starting Price: ~~US\$5,895~~

~~Doubles the indexing stations for increased tooling capacity and flexibility~~

~~4k
SPEED~~

~~12 hp
POWER~~

~~Internal
DRIVE~~

Products and Price List Update

- 40GAL replaces 55GAL as a standard feature on SB-28 and SB-28Y in all regions.

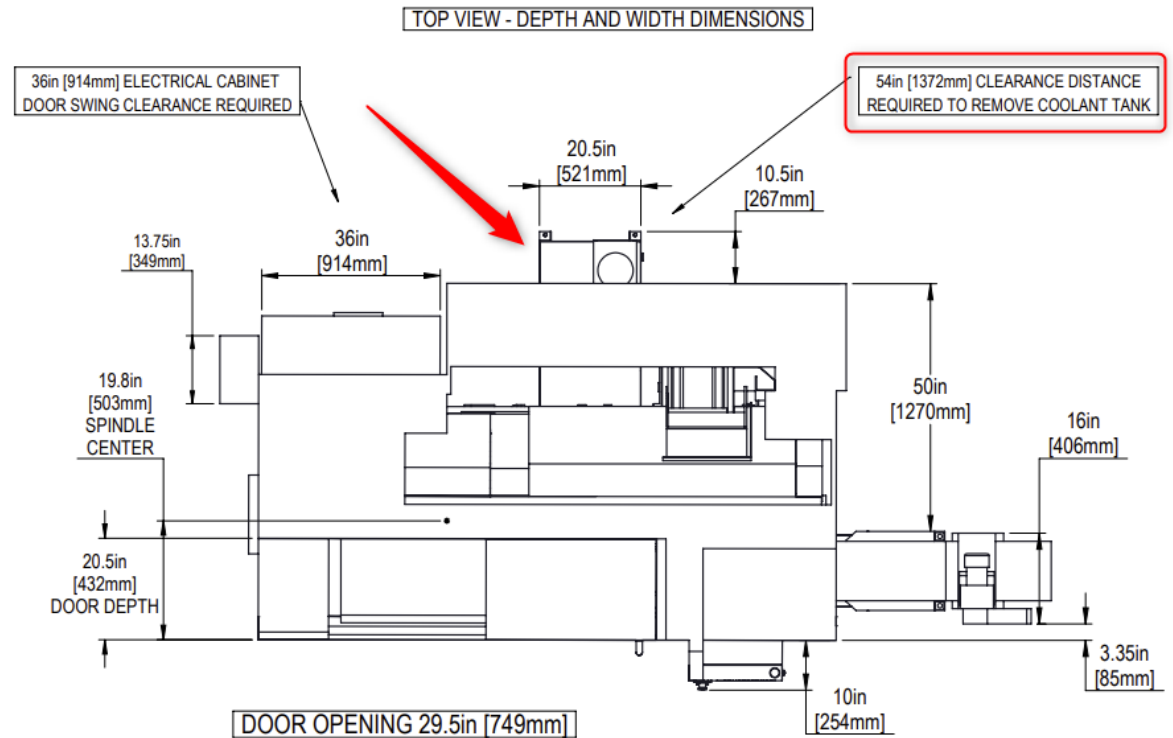
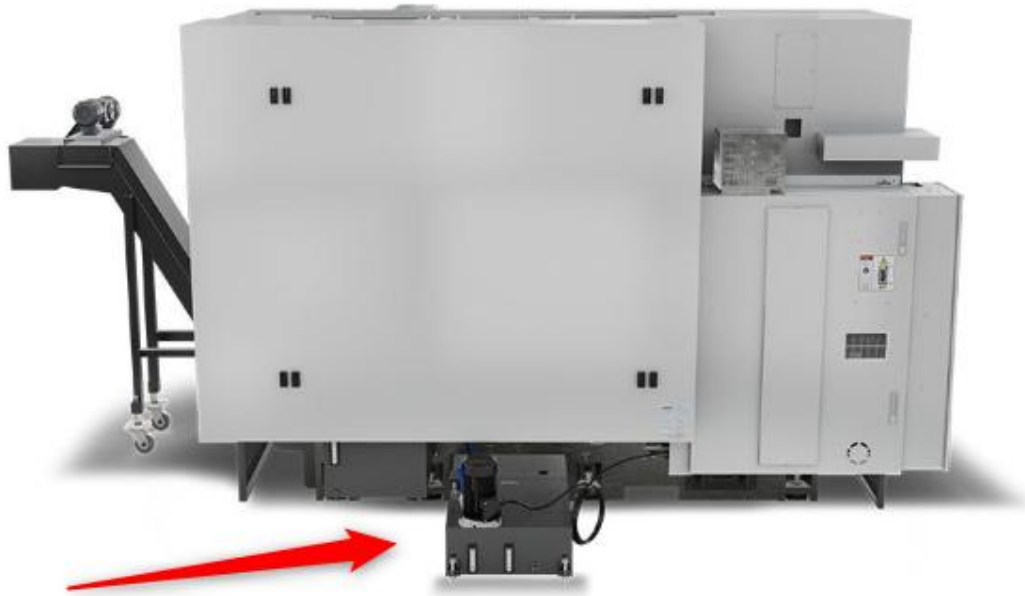

GENERAL

S.A.E

METRIC

Coolant Capacity

40 gal

151 L

Products and Price List Update

- 100GAL replaces 55GAL as a standard feature on SB-35, SB-35Y, SB-35L, SB-35LY in all regions.



Products and Price List Update

- 2.5K-40HP-A2-8 replaces 3.2K-40HP-A2-8 as a standard feature on SB-35, SB-35Y, SB-35L, SB-35LY in all regions.



SB-35Y Box Way Lathe

Starting Price: US\$153,995

The Haas SB-35Y offers the high dynamic stiffness, load-bearing capacity, and vibration damping associated with traditional box way machines, combined with the powerful, easy-to-use Haas control, and backed by the industry-leading support of the Haas Factory Outlet network.

- BMT65 turret
- Hardened and precision ground ways
- Hand-scraped Turcite-B slideways
- 30° slant-bed with 30° Y-axis wedge angle
- Compact footprint

NOTE: The SB-35Y is not compatible with the Haas Bar Feeder, and is not available with a parts catcher.



COMPARE MACHINES

EXPLORE ALL INVENTORY [↗](#)

Available for order in the U.S., Canada, Mexico, and Europe, with estimated delivery Q1 2026.

Products and Price List Update

- Release HFL-3015-3 for sale in US/Canada/Mexico. HFL-3015-3 replaces HFL-3015.

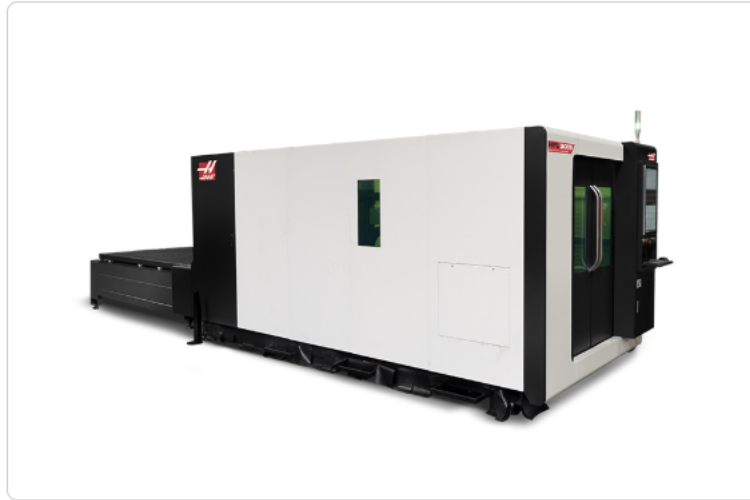

HFL-3015 Fiber Laser, 3 kW

Starting Price: US\$149,995

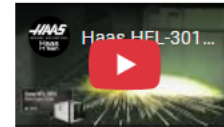

- 3 kW fiber laser
- 120" x 60" (3050 x 1530 mm) work area
- High-speed autofocus sensor head
- Programmable assist gas ports (air, oxygen, nitrogen)
- Dual automatic shuttle tables
- Windows-based laser controller w/large touchscreen
- CypCut laser programming software with nesting capability
- Internal and external cameras for process/safety monitoring
- Remote pendant
- Full enclosure for safety and protection
- Heat-isolated machine bed for stability
- Negative pressure dust removal system

The Haas HFL-3015-3 is a fully enclosed 3 kW CNC fiber laser cutting machine with a high-speed autofocus sensor head and a large work area. The unit has dual shuttle tables that exchange automatically, allowing raw material and finished parts to be loaded and unloaded on one table, while the other table is in the machine, providing near continuous operation.

The 3 kW fiber laser cutting head is optimized to provide excellent cut quality and high efficiency, and features automatic focusing to reduce set-up time and increase accuracy. The laser easily cuts a variety of metals, including carbon steel, stainless steel, aluminum alloy, brass, copper, and even titanium alloy.

MATERIAL CUTTING RANGE

MATERIAL	SAE	METRIC
Carbon Steel	0.016" - 0.71"	0.4 - 18 mm
Stainless Steel	0.016" - 0.31"	0.4 - 8 mm
Aluminum	0.016" - 0.24"	0.4 - 6 mm
Brass	0.016" - 0.20"	0.4 - 5 mm

NOTE: Maximum cutting range varies with material thickness, type of assist gas used, part geometry, cutting speeds, and desired cut quality.

Available to order in North America only, with expected delivery Q1 2026.

Products and Price List Update

- Release HFL-3015-6 for sale in US/Canada/Mexico.

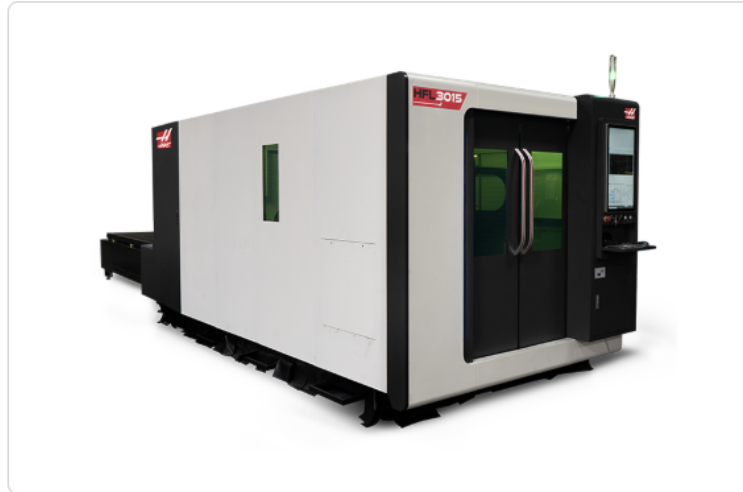

HFL-3015 Fiber Laser, 6 kW

Starting Price: **US\$179,995**

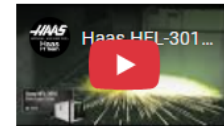

- 6 kW fiber laser
- 120" x 60" (3050 x 1530 mm) work area
- High-speed autofocus sensor head
- Programmable assist gas ports (air, oxygen, nitrogen)
- Dual automatic shuttle tables
- Windows-based laser controller w/large touchscreen
- CypCut laser programming software with nesting capability
- Internal and external cameras for process/safety monitoring
- Remote pendant
- Full enclosure for safety and protection
- Heat-isolated machine bed for stability
- Negative pressure dust removal system

The Haas HFL-3015-6 is a fully enclosed 6 kW CNC fiber laser cutting machine with a high-speed autofocus sensor head and a large work area. The unit has dual shuttle tables that exchange automatically, allowing raw material and finished parts to be loaded and unloaded on one table, while the other table is in the machine, providing near continuous operation.

The 6 kW fiber laser cutting head is optimized to provide excellent cut quality and high efficiency, and features automatic focusing to reduce set-up time and increase accuracy. The laser easily cuts a variety of metals, including carbon steel, stainless steel, aluminum alloy, brass, copper, and even titanium alloy.

MATERIAL CUTTING RANGE

MATERIAL	SAE	METRIC
Carbon Steel	0.016" - 0.87"	0.4 - 22 mm
Stainless Steel	0.016" - 0.63"	0.4 - 16 mm
Aluminum	0.016" - 0.47"	0.4 - 12 mm
Brass	0.016" - 0.39"	0.4 - 10 mm

NOTE: Maximum cutting range varies with material thickness, type of assist gas used, part geometry, cutting speeds, and desired cut quality.

Available to order in North America only, with expected delivery Q1 2026.

Products and Price List Update

- Remove VARIABLE FLOW CLNT as an available option on GM-2-5AX in all regions.



Variable Flow Coolant

Standard on some models

Control coolant flow via M-code

Products and Price List Update

- Add HIGH PRESSURE COOL as an available option on GM-2-5AX in all regions.



High-Pressure Flood Coolant

Starting Price: **US\$2,195**



- Fixed displacement gear pump provides up to 14 gpm (53 L/min) of flow
- Provides up to 60 psi (4 bar) of coolant pressure at the spindle
- Clears chips from deep pockets to prevent recutting
- Higher coolant flow for deep-hole boring
- Reduces material work hardening and increases tool life
- Produces better surface finishes by clearing chips

The number one cause of premature tool failure is re-cutting chips. Our High-Pressure Flood Pump delivers up to 45% more coolant to the cutting zone – at higher pressure – to flush out chips and swarf. High-volume, high-pressure coolant is delivered through our multi-nozzle flood coolant ring to maximize efficiency.

ATTENTION: This system is louder than the standard flood coolant system, due to the higher pressures involved, and the spur gear drive system. It is operating as expected.

NOTE: Not compatible with the **Auxiliary Coolant Filter (ACF)** option.

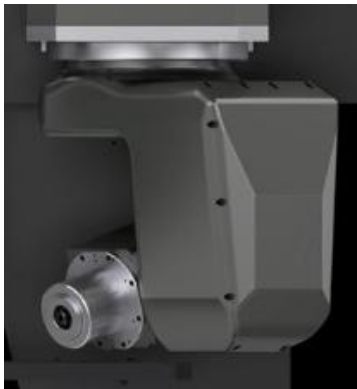

Products and Price List Update

- Release COBOT PKG-20KG-F for sale in all regions.



Haas 20 kg Cobot Package, Fanuc

Starting Price: US\$64,995

All-in-one cobot kit for your new machine! The Haas 20 kg Cobot Package includes everything required to run your new cobot directly from the Haas control. This kit features the **HC20-F Cobot** with a 20 kg capacity, tablet teach pendant, dual pneumatic grippers, protective barriers, a parts table, a part flip station, and all necessary hardware and cables.

20 KG CAPACITY | 1418 MM REACH

AVAILABLE ON:

Small and medium VFs, ST-20 through ST-35, DS series, DC-1s, DC-2s, DTs, DMs, UMC-400/SS, UMC-500/SS, and UMC-750/SS

**Does not ship pre-built. The temporary mounting base is for optional use, and is not included in Europe. Floor mounting is recommended. Cobot carries a 2-year warranty.*

COBOT PKG-20KG-F: December

Products and Price List Update

- Release HAB-3232-CE for sale in HE and CH.



HAB-3232-CE Automatic Bandsaw

Starting Price: 26.495 €



- Max cutting height – 12.6" (320 mm)
- Max cutting width – 12.6" (320 mm)
- AI mode
- Wheel adjustable feedrate
- Hydraulic blade tension
- Automatic chip auger
- Bar stacking capability
- Manual and automatic modes
- Memory for multiple jobs
- Full CE safety controls and guarding

Elevate shop productivity and precision with the Haas HAB-3232-CE Automatic Bandsaw, designed to meet the rigorous demands of automated metal cutting. Engineered for precision, our bandsaw delivers smooth, clean cuts on a variety of metals, from steel to aluminum. The HAB-3232-CE can cut different lengths in the same cycle, and has bar-stacking capability for extra efficiency.

Featuring an intuitive control panel, the HAB-3232-CE offers user-friendly operation. Use AI Mode to let the saw determine its own feedrate, or use the adjustment wheel to make fine adjustments and determine what feedrate works best.

Includes full CE safety controls and guarding.

Products and Price List Update

- Add 12K-40T-GREASE-IN as an option on VF-3SS, 3SSYT, 4SS, 5SS, VM-2, VM-3 in all regions.



12,000-rpm Inline Grease-Packed Spindle

*Starting Price: **US\$1,995***

Optional inline spindle for 40-taper mills

12k
SPEED

40
TAPER

Inline
DRIVE

Products and Price List Update

- Price Drop on 30K spindle option in all regions.



30,000-rpm Spindle

Starting Price: **US\$19,995**

High-speed 30-taper spindle for VF Series and Mold Machines

30k
SPEED

30
TAPER

20 hp
POWER

Belt
DRIVE

Max. Torque - 18 ft-lb (25 Nm) 20% of standard

Video Update

Video Update

Recently Released Videos

- Do You Use Drills? Watch This Video to Decode Drill Indexes and Charts - Haas Tip of the Day - <https://www.youtube.com/watch?v=C6xrteQ5fgI>
- Haas DC-2/40 Cutting Aluminum and Steel - Haas Automation, Inc. <https://www.youtube.com/watch?v=YqUkrbcrtmw>
- Leave the Chips Behind! With FORM TAPPING - Haas Automation Tip of the Day <https://www.youtube.com/watch?v=QLotYkee1Jw&t=165s>
- END CHATTER! New Anti-Vibration Boring Bars at HaasTooling.com - Haas Automation, Inc. <https://www.youtube.com/watch?v=F5YwMnUVGOs>

Video Update

Recently Released Videos

- Do You Use Drills? Watch This Video to Decode Drill Indexes and Charts - Haas Tip of the Day - <https://www.youtube.com/watch?v=C6xrteQ5fgI>

Haas Tip of the Day Video

- Informative video
- Twist Drill History
- New Drill Charts
- Worth the watch!
- Check it out
- Share it as needed



Video Update

Recently Released Videos

- Haas DC-2/40 Cutting Aluminum and Steel - Haas Automation, Inc.
<https://www.youtube.com/watch?v=YqUkrbcrtmw>

Cutting Demo Video

- Informative video
- Shows the DC-2/40 Performance
- Also shows various Haas Tooling
- Switches to Steel at 2 min. mark
- Check it out
- Share it as needed



Video Update

Recently Released Videos

- Leave the Chips Behind! With FORM TAPPING - Haas Automation Tip of the Day
<https://www.youtube.com/watch?v=QLotYkee1Jw&t=165s>

Haas Tip of the Day Video

- Informative video
- Form Taps
- Increased Tool Life
- Higher Speeds & Feeds
- Under 20 Min.
- Worth the watch!
- Check it out
- Share it as needed



Video Update

Recently Released Videos

- END CHATTER! New Anti-Vibration Boring Bars at HaasTooling.com - Haas Automation, Inc.
<https://www.youtube.com/watch?v=F5YwMnUVGOs>

Haas Tooling Video

- Informative video
- The Trick to Deep Hole Boring
- Up to 10X Diameter
- Modular Design
- Worth the Watch!
- Check it out
- Share it as needed



Tooling Update

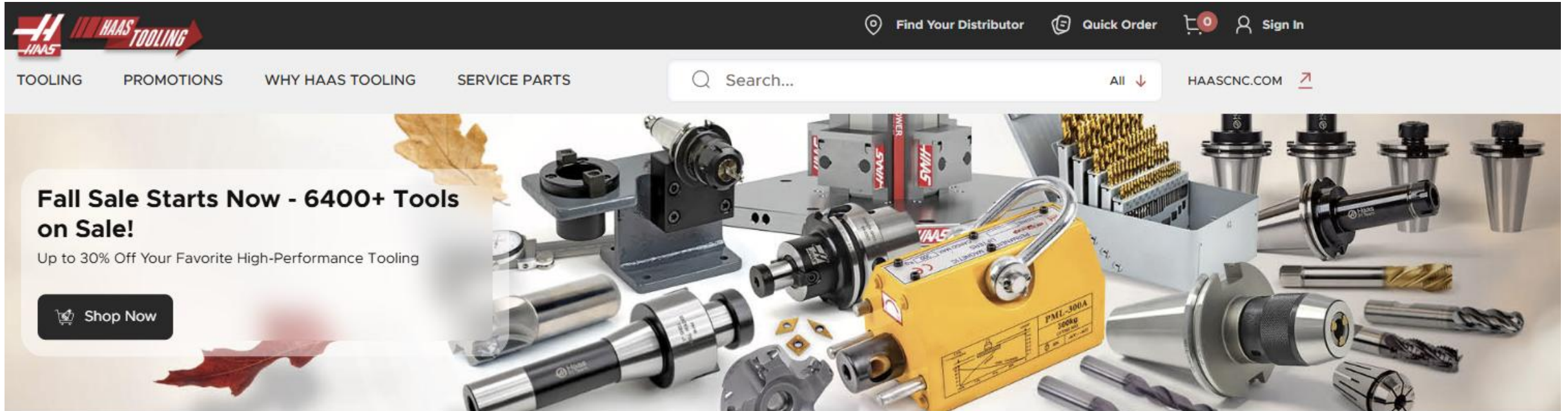

WINNER'S CIRCLE Update

Still On Sale - Only \$10 – 90% off the already reduced price

Over 16,000 Subscriptions and Growing

Tooling Update, Global Except Europe & China



Solid Carbide APX End Mills

49



Right-Angle Heads

3



HML-1 Tooling Starter Kit
Part #: 08-2142
\$895.95

- 1 + Add

+83 Items



Pocket Mill Tooling Starter Kit, CT40
Part #: 08-2105
\$1,399.95

- 1 + Add



Hard Steel Non-Machinable Serrated Lathe Jaws for 8" (210mm) Chuck, Reversible, 3 Pc. Set
Part #: 05-0803
\$449.95

- 1 + Add



12" (300mm) Haas Smart Height Gauge
Part #: 09-0632A
\$7,999.95

- 1 + Add

- APX End Mills
- Right Angle Heads
- HML-1 Starter Kit
- Pocket Mill Starter Kit
- Hard Steel Serrated Lathe Jaws
- Smart Height Gauge
- Straight Pipe Taps

10% OFF ENDS FRIDAY!
Winner's Circle Exclusive - Join Today!

30 HOURS 42 MINUTES 29 SECONDS

Find Your Staff/Order | Get Order | Sign In

TOOLING | PROMOTIONS | WHY HAAS TOOLING | SERVICE PARTS

Search...

HAASINC.COM

MT Toolholding | Winner's Circle | Shop Support | Automation Accessories | Tool Management | Measuring & Inspection | Mill Workholding | Mill Tooling

MT Toolholding | Right-angle heads

SUBCATEGORIES

- Pull Studs / Retention Knobs
- End Mill Holders
- Small Mill Holders
- Drill Fix Holders
- ER Collet Chucks
- Milling Chucks & Collets
- NC Drilling Chucks
- Hydraulic Milling Chucks & ...
- Mill Broaching Holders
- Toolholder Attachments & ...
- Right-angle Collets
- Right-angle Heads**

Right-Angle Heads Technical Details

Filters

Collet Series [A] Tool Length

Right-Angle CT40 Half-Series Drill/Mill Angle Head, Haas Toolholding by MST/Kitagawa
Part # 04-602
\$2,695.95 Add

Right-Angle CT40 Half-Series Tap Angle Head, Haas Toolholding by MST/Kitagawa
Part # 04-603
\$2,795.95 Add

Right-Angle CT40 Mini Half-Series Drill/Mill Tap, 0.5 in. Angle Head, Haas Toolholding by MST/Kitagawa
Part # 04-604
\$3,299.95 Add

Recently Viewed

92° Dia. Carbide 4-Flute End Mill
4-Flute, High-ALN Coating, 92° Shank x 2° LDC, O-Coat
Chamfered End
Part # 04-3334
\$76.35 Add

8MTL2 90° Axial-Low-Cut-Down Holder, Haas Toolholding by
8MTL2
Part # 04-0732
\$1,979.97 Add

8MTL1 0-degree Bevel Low-Cut-Down Holder, Haas Toolholding by
8MTL1
Part # 04-0467
\$999.97 Add

Right-Angle CT 60 Half-Series Drill/Mill Angle Head, Haas Toolholding by MST/Kitagawa
Part # 04-602
\$2,695.95 Add

Right-Angle CT10 Half-Series Tap Angle Head, Haas Toolholding by MST/Kitagawa
Part # 04-603
\$2,795.95 Add

HAAS RIGHT ANGLE HEADS BY MST/KITAGAWA

Unlock new machining possibilities with Haas right angle heads. Designed for swarfless saw with the Mini-Spindle C-Axis, and adaptable to any machine with the proper locking block, these precision tools let you reach features that a standard mill spindle simply can't. From deep bores to the ends of long parts, or tight areas blocked by surrounding features, right angle heads expand what your machine can do. Best of all, they're fully compatible with Haas Side-Mount Tool Changers, keeping your setups efficient and production-ready.

Drill/Mill Heads
The go-to solution for versatility. Perfect for drilling and light milling, these heads use DMT-1 collets to support a wide variety of tools.

Tap Heads
Built-in tension/compression technology automatically compensates for spindle synchronization, protecting both tool and workpiece. Combined with precision taper sleeves that are tapered for each tap size, these heads ensure maximum tap life and the highest-quality threads.

Mini Heads
Big performance in a small package. With a slimmer body and extra-long reach, Mini Heads give you clearance where others can't—ideal for internal features and tall part geometry. Featuring a standard ER-11 collet chuck, they provide broad cutter compatibility to handle a range of operations.



MT Toolholding | Right-angle heads | 04-602

Right-Angle CT40 Half-Series Drill/Mill Angle Head, Haas Toolholding by MST/Kitagawa
Part # 04-602 | 90° | 0.5 in. | 0.5 in.

\$2,695.95 Special Order \$2,426.35

7 to stock | Post-Delivery from 888

Add to cart

Get additional \$1.00 Off and Free Delivery
Add More to Cart
FREE SHIP DAY DELIVERY



DESCRIPTION

The go-to solution for versatility. Perfect for drilling and light milling, these heads use DMT-1 collets to support a wide variety of tools.

DOWNLOAD DOCUMENTS

Product Manual | 3D Model (STEP)

TECHNICAL SPECIFICATIONS

System of Measurement	Universal ANSI, ISO
Taper	CT40
Collet Series	DMT-1
(A) Tool Length	6.51 in 166.6 mm
(B) (L) Shank Length	6.18 in 157.38 mm
(C&D) Overall Height	3.98 in 101.0 mm
(D&E) Overall Width	4.88 in 124.0 mm
(H) Diameter	2.86 in 72.6 mm
Cutting Direction	CCW
Maximum RPM	4000
Collet Taper	1:1
Weight	8.8 lbs 3.9 kg
Country of Origin	Japan

Thumbnail 01 Image

HAAS RIGHT ANGLE HEADS BY MST/KITAGAWA

Unlock new machining possibilities with Haas right angle heads. Designed for swarfless saw with the Mini-Spindle C-Axis, and adaptable to any machine with the proper locking block, these precision tools let you reach features that a standard mill spindle simply can't. From deep bores to the ends of long parts, or tight areas blocked by surrounding features, right angle heads expand what your machine can do. Best of all, they're fully compatible with Haas Side-Mount Tool Changers, keeping your setups efficient and production-ready.

Drill/Mill Heads
The go-to solution for versatility. Perfect for drilling and light milling, these heads use DMT-1 collets to support a wide variety of tools.

Tap Heads
Built-in tension/compression technology automatically compensates for spindle synchronization, protecting both tool and workpiece. Combined with precision taper sleeves that are tapered for each tap size, these heads ensure maximum tap life and the highest-quality threads.

Mini Heads
Big performance in a small package. With a slimmer body and extra-long reach, Mini Heads give you clearance where others can't—ideal for internal features and tall part geometry. Featuring a standard ER-11 collet chuck, they provide broad cutter compatibility to handle a range of operations.





WINNER'S CIRCLE Update

Still On Sale - Only €10 – 90% off the already reduced price

Over 16,000 Subscriptions and Growing

HAE - Tooling Update



3-Sided 3" Self-Centering Vise Pyramid Kit
Part #: 08-1986

€3,599.95

- 1 +

Add



3-Sided 5" Self-Centering Vise Pyramid Kit
Part #: 08-1987

€4,399.95

- 1 +

Add



12" (300mm) Haas **Smart Height**
Gauge

Part #: 09-0632A

€6,999.95

- 1 +

Add



24" (600mm) Haas **Smart Height**
Gauge

Part #: 09-0631A

€9,499.95

- 1 +

Add



Air Compressors

2

+6 Items

- 3-Sided Vise Pyramid
- Smart Height Gauge
- Air Compressors

Marketing Update



DC-SERIES

DISCOUNTS
AS HIGH AS
33% OFF

PRICE DROP



ALL MODELS - FOR A LIMITED TIME ONLY

LEARN MORE



Fall Sale

6400+ **UP TO 30% OFF**
tools on sale

FREE NEXT-DAY DELIVERY FOR A YEAR
JOIN WINNER'S CIRCLE TODAY
\$10 (\$95)



WINNER'S CIRCLE

SHOP HAAS TOOLING

Marketing Update



YEAR-END SALE!
 SAVE ON ALL IN-STOCK MACHINES
 HAAS



HAAS
 SPINDLE MILL & MANUAL LATHE
BUY THEM TOGETHER
 SAVE 10%
 HAAS



HAAS TOOLING.COM
Fall Sale
6400+ UP TO 30% OFF
 tools on sale
 FREE NEXT-DAY DELIVERY FOR A YEAR
 \$10 (\$95)
 HAAS



DC-SERIES
 DISCOUNTS AS HIGH AS 33% OFF
PRICE DROP
 ALL MODELS - FOR A LIMITED TIME ONLY



VOP
 VALUE OPTION PACKAGES
A NEW WAY TO SAVE



SECTION 179
TAX SAVINGS FOR 2025
NO PAYMENTS UNTIL 2026!



SR-SERIES
 HAAS SHEET ROUTERS
BUY NOW & GET 25% OFF
 FOR A LIMITED TIME ONLY



30% OFF VC-400SS
SAVE UP TO \$72K on specially configured, fully-loaded VC-400SS for only \$169,995
 (As low as \$1,681 per month)



HOT DEALS

DEMO & PRE-OWNED

CANCELED ORDERS

Hot Deals – 15% to 33% Off
Demo Machines – 15% to 30% Off
Canceled Orders – 15% to 40% Off

Marketing Tools

View Edit Track Devel

*** All images are clickable ***



MARKETING CAMPAIGNS

HAAS TOOLING HOME PAGE

[Haas Tooling Promo page](#)

[How to redeem Online Tooling Promos](#)

2025 AVAILABLE DIGITAL MARKETING CAMPAIGNS and MODEL GUIDES, PDFs,

CATALOGS

*Check Marketing Campaign page for info about HFO Demo Day.

Tooling Kits Explained (08/PCK/EK)

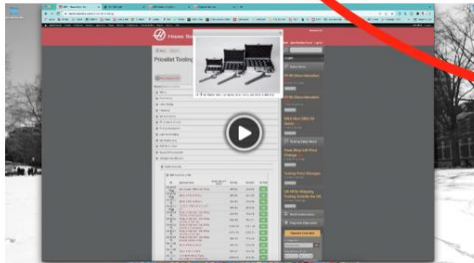

DC PRICE DROPS

High-Speed Drill Centers

Date updated: October 6, 2025

Landing Page ↓

DC Price Drops Landing Pages

Email ↓

Marketing Update

2025 AVAILABLE DIGITAL MARKETING CAMPAIGNS + MODEL GUIDES/PDFS/CATALOGS

These campaigns will be running throughout 2025. Email HFOEmailSupport@haascnc.com if you want to have Haas email your customer base regarding any of the below campaigns.

CURRENT LIVE MARKETING CAMPAIGNS

NEW Marketing Campaigns added

- **160-Pocket Side-Mount Tool Changer *NEW**
- **HML-1 Manual Lathe *NEW**
- **120-Pocket Side-Mount Tool Changer *NEW**
- **Mill-Spindle C-Axis *NEW**
- **Knee Mill *NEW**
- **Box Way Lathe *NEW**
- **HFL-3015 Fiber Laser *NEW**
- **DMs/DTs *NEW**
- **Hot Deals on In-Stock Machines *NEW**
- **Financing Rates *NEW**
- **SR-3015 Sheet Router *NEW**
- **HFO Demo Day *NEW**
- **DC-Series *NEW**
- **GM-1 Gantry Mills *NEW**

NEW Sales

- **Flash Sale *NEW**
- **Year-End Stock Sale *NEW**
- **Value Option Packages (VOP) *NEW**

Ongoing Marketing Campaigns Available

- EU Models
- Mini Mill Redesign
- Rotaries
- Customer Testimonials
- Showroom Machines/Local Inventory
- Energy Savings
- New to CNC
- New to Haas
- Advanced Haas User
- Industry - Aerospace
- Industry - Firearms
- Industry - Medical/Dental
- Haas Makes It Easy
- Why Haas
- First-Time Buyers
- Small Footprint
- Affordable Machines
- Most Popular Machine
- Robot Competition
- Most Popular Machine
- Fully Integrated Pallet Pools
- Why Buy a Robot
- Trade In, Trade Up
- Machine Highlight
- Small VF
- EC-400
- VC-400
- UMC-500
- 50-Taper
- ST-28Y
- VF-2YT Series Pallet Pool

TOOLING MARKETING CAMPAIGNS

- **Haas Cobot *NEW**
- Benefits of Haas Tooling
- Haas Workholding by Kurt
- Ready2Run
- Ready2Machine

PDFS/CATALOGS/MODEL GUIDES

Available in Multiple Languages

- **Haas Journal *NEW**
- **Model Guides *NEW**
- **Shop Notes *NEW**
- EU Series PDFs
- Haas Tooling Winner's Circle Introduction Flyer
- Haas Tooling Winner's Circle Letter
- Haas Tooling Winner's Circle Poster
- Haas Tooling 4 Pagers
- Haas Tooling Catalog
- Haas Guide to Automation: Robots
- V-Model PDFs
- Catalog on Haas Automated Systems

HFO EVENTS

Fill out the survey below to start the process of getting marketing materials created for your event. You must submit the survey a minimum of 2 months before your event. *Date updated: Jan 2025*

[EVENT SURVEY](#)

**Click here for the Demo Day survey and marketing materials.*

Rate Factors for CNCA Promos for USA, Canada, & HAE -September 2025 pb JM .xlsx

HFO Blind Discount is 1% of the financed amount

Effective Oct 1, 2025

Term	Skip Days	Months						
		12	24	36	48	60	72	84
10%		0.00%	2.49%	3.49%	4.49%	4.99%		
20%		0.00%	1.49%	2.49%	2.99%	4.49%	5.49%	5.99%
25%		0.00%	0.00%	1.49%	2.49%	3.49%	4.99%	5.49%
30%		0.00%	0.00%	0.00%	1.49%	2.99%	4.49%	4.99%
50%		0.00%	0.00%	0.00%	0.00%	2.99%	4.49%	4.99%
20%	90	1.49%	1.99%	2.99%	3.99%	5.49%	5.99%	6.49%
30%	180	1.99%	2.49%	3.49%	4.49%			

Term	Skip Days	RATE FACTORS						
		12	24	36	48	60	72	84
10%		0.08333	0.04276	0.02930	0.02280	0.01887		
20%		0.08333	0.04232	0.02886	0.02213	0.01864	0.01634	0.01461
25%		0.08333	0.04167	0.02842	0.02190	0.01819	0.01611	0.01437
30%		0.08333	0.04167	0.02778	0.02147	0.01797	0.01587	0.01413
50%		0.08333333	0.0416667	0.0277778	0.02083	0.01797	0.01587	0.01413
20%	90	0.08422	0.04268	0.02923	0.02273	0.01928	0.01674	0.01501
30%	180	0.08494	0.04321	0.02973	0.02323			

FINANCING RATES *NEW

CNCA Financing Rates are Extended to October 31, 2025.

Available for: US, Canada, HAE (Denmark, Germany, France, Spain, Portugal, Belgium, Luxembourg, Estonia, Latvia, Lithuania, Czech Republic, Slovenia, Slovakia, and Greece)

Date updated: October 1, 2025

Rates Chart

Rate Factors for CNCA Promos for USA, Canada, & HAE -September 2025 pb JM .xlsx

HFO Blind Discount is 1% of the financed amount

Effective Oct 1, 2025

Term	Skip Days	Months						
		12	24	36	48	60	72	84
10%		0.00%	2.49%	3.49%	4.49%	4.99%		
20%		0.00%	1.49%	2.49%	2.99%	4.49%	5.49%	5.99%
25%		0.00%	0.00%	1.49%	2.49%	3.49%	4.99%	5.49%
30%		0.00%	0.00%	0.00%	1.49%	2.99%	4.49%	4.99%
50%		0.00%	0.00%	0.00%	0.00%	2.99%	4.49%	4.99%
20%	90	1.49%	1.99%	2.99%	3.99%	5.49%	5.99%	6.49%
30%	180	1.99%	2.49%	3.49%	4.49%			

Term	Skip Days	RATE FACTORS						
		12	24	36	48	60	72	84
10%		0.08333	0.04276	0.02930	0.02280	0.01887		
20%		0.08333	0.04232	0.02886	0.02213	0.01864	0.01634	0.01461
25%		0.08333	0.04167	0.02842	0.02190	0.01819	0.01611	0.01437
30%		0.08333	0.04167	0.02778	0.02147	0.01797	0.01587	0.01413
50%		0.08333333	0.0416667	0.0277778	0.02083	0.01797	0.01587	0.01413
20%	90	0.08422	0.04268	0.02923	0.02273	0.01928	0.01674	0.01501
30%	180	0.08494	0.04321	0.02973	0.02323			

RATES CHART

2025 CNCA Payment Calculator

\$ Total Deal	Down Payment	12 Months	24 Months	36 Months	48 Months	60 Months	72 Months	84 Months
\$ 20,000.00	\$ 2,000.00	\$ 1,846.40	\$ 2,007.00	\$ 2,052.00	\$ 2,098.30	\$ 2,145.00	\$ 2,191.20	\$ 2,237.00
\$ 25,000.00	\$ 2,500.00	\$ 2,365.00	\$ 2,500.00	\$ 2,535.00	\$ 2,570.00	\$ 2,605.00	\$ 2,640.00	\$ 2,675.00
\$ 30,000.00	\$ 3,000.00	\$ 2,883.60	\$ 3,000.00	\$ 3,035.00	\$ 3,070.00	\$ 3,105.00	\$ 3,140.00	\$ 3,175.00
\$ 35,000.00	\$ 3,500.00	\$ 3,402.20	\$ 3,500.00	\$ 3,535.00	\$ 3,570.00	\$ 3,605.00	\$ 3,640.00	\$ 3,675.00
\$ 40,000.00	\$ 4,000.00	\$ 3,920.80	\$ 4,000.00	\$ 4,035.00	\$ 4,070.00	\$ 4,105.00	\$ 4,140.00	\$ 4,175.00
\$ 45,000.00	\$ 4,500.00	\$ 4,439.40	\$ 4,500.00	\$ 4,535.00	\$ 4,570.00	\$ 4,605.00	\$ 4,640.00	\$ 4,675.00
\$ 50,000.00	\$ 5,000.00	\$ 4,958.00	\$ 5,000.00	\$ 5,035.00	\$ 5,070.00	\$ 5,105.00	\$ 5,140.00	\$ 5,175.00

CNCA PAYMENT CALCULATOR - EXCEL FILE

Rates PDF for US Customers

(Updated October 1, 2025)

Rates PDF for HAE Customers

(Updated October 1, 2025)



US CUSTOMER FINANCING PDF



HAE Customer Financing PDF

VALUE OPTION PACKAGES

PROMOTIONS & FINANCING

NEW PRODUCTS

GENERAL & MACHINE

TOOLING

PDFS AND BROCHURES

CURRENT PROMOTIONS

US/Canada Promotions

- ✓ Year-End Stock Sale **NEW*
- ✓ Flash Sale **NEW*
- ✓ Super-Speed Promo **NEW*
- ✓ Financing Rates **NEW*

HAE Promotions

- ✓ Year-End Stock Sale **NEW*
- ✓ Super-Speed Promo **NEW*
- ✓ Financing Rates **NEW*

Other Promotions & Events

- ✓ HFO Events
- ✓ HFO Demo Day

CNCA FINANCING PRESENTS:

CHOOSE YOUR OWN FINANCING

<p>LOWEST DOWN PAYMENT</p> <p>10% DOWN 4.99% INTEREST FOR 60-MONTHS.</p> <p><small>PAYMENTS AS LOW AS</small> \$1,698 PER MONTH</p>	<p>LOWEST INTEREST</p> <p>0% FOR 48 MONTHS REQUIRES LARGER DOWN PAYMENT</p> <p><small>PAYMENTS AS LOW AS</small> \$1,042 PER MONTH</p>	<p>LONGEST TERM</p> <p>84-MONTH TERM WITH RATES AS LOW AS 4.99%*</p> <p><small>PAYMENTS AS LOW AS</small> \$707 PER MONTH</p>
--	---	--

SAMPLE PAYMENTS ARE BASED ON A \$100,000 CNC MACHINE PURCHASE.

SAVE \$8,099 IN INTEREST!
(BASED ON 0.00% FOR 36 MONTHS, COMPARED TO PRIME RATE AT 7.25% INTEREST)

NO PRE-PAYMENT PENALTIES EVER! **UP TO 6-MONTH SKIP AVAILABLE**

HAAS **Haas FT Team** **Haas Automation, Inc.** **Haas Automation Europe**
OFFICIAL MACHINE TOOL 2800 Sturgis Rd., Orland, CA, USA, +1-805-278-1800 Mercuriusstraat 28, B-1930 Zaventem, Belgium

Specifications subject to change without notice. Not responsible for typographical errors. Machines shown with optional equipment. Actual product appearance may differ. Pricing subject to change without notice.

INSANE FINANCING FOR YOUR NEXT HAAS CNC

DOWN PAYMENT	CHOOSE YOUR TERM						
	12-MONTHS	24-MONTHS	36-MONTHS	48-MONTHS	60-MONTHS	72-MONTHS	84-MONTHS
10% DOWN	0.00%	2.49%	3.49%	4.49%	4.99%	N/A	N/A
20% DOWN	0.00%	1.49%	2.49%	2.99%	4.49%	5.49%	5.99%
25% DOWN	0.00%	0.00%	1.49%	2.49%	3.49%	4.99%	5.49%
30% DOWN	0.00%	0.00%	0.00%	1.49%	2.99%	4.49%	4.99%
50% DOWN	0.00%	0.00%	0.00%	0.00%	2.99%	4.49%	4.99%
20% DOWN + 3 MO SKIP	1.49%	1.99%	2.99%	3.99%	5.49%	5.99%	6.49%
30% DOWN + 6 MO SKIP	1.99%	2.49%	3.49%	4.49%	N/A	N/A	N/A

* Financing Terms, Conditions, and Exceptions: References are to an implied interest rate under a conditional sales contract. Interest accrues during the skip period. Down payment, rate, and terms of financing are dependent upon credit approval.

Eligible businesses should have three or more years of operation under current ownership. U.S. and Canada only.

All programs are 10% - 50% down. Must put a minimum of 20% down to get no payments for 3 months. Monthly payment does not include applicable taxes, rigging, or freight charges.

Certain equipment (e.g., stand-alone Rotaries, Shop Equipment, Bar Feeders, etc.) are subject to different rates, terms, and down-payment requirements, unless financed with a machine. No prepayment penalty on any program. Not responsible for misprints or typographical errors. Offer valid on new machine orders placed from October 1 through October 31, 2025.

EU-SERIES



Haas Lathes & Vertical Mills.
More Choices. More Value.

[LEARN MORE](#)



HAAS TOOLING.COM

Autumn sale

3000+

tools on sale **UP TO -50%**

FREE EXPRESS DELIVERY FOR A YEAR
JOIN WINNER'S CIRCLE TODAY
€10 (€95) **WINNER'S CIRCLE**

[SHOP HAAS TOOLING](#)

Machines Configured Exclusively for Europe

EU SERIES: UP TO 34% OFF

MORE CHOICES, MORE VALUE – JUST FOR EUROPE

[LEARN MORE](#)

HAE Marketing Update



YEAR-END SALE!
SAVE ON ALL IN-STOCK MACHINES

HAAS



HAAS TOOLING.COM
Autumn sale
3000+ UP TO **-50%**
tools on sale
FREE EXPRESS DELIVERY FOR A YEAR
NEW MEMBER'S CIRCLE TOGETHER €10 (€95) WPMEDS



DC-SERIES
DISCOUNTS AS HIGH AS 30% OFF
PRICE DROP
ALL MODELS - FOR A LIMITED TIME ONLY

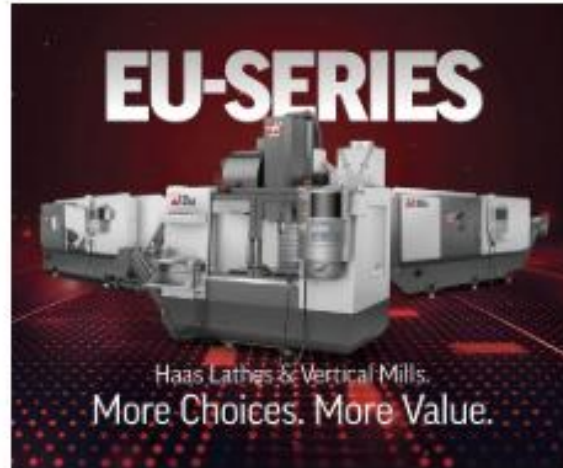

EU-SERIES
Haas Lathes & Vertical Mills.
More Choices. More Value.



SR-SERIES
HAAS SHEET ROUTERS
BUY NOW & GET 25% OFF
FOR A LIMITED TIME ONLY



SAVE ON ALL **IN-STOCK** MACHINES

Up to **-35%** on In-Stock CNC Machines

Up to **-25%** on Built-to-Order CNC Machines

HOT DEALS

DEMO & PRE-OWNED

CANCELED ORDERS

Hot Deals 10% to 35% Off!

Demo Machines @ 15% to 40% Off!

Canceled Orders @ 15% to 36% Off!

HAE Marketing Update

CHOOSE YOUR FINANCING

**NO MODEL
RESTRICTIONS**

**UP TO 6-MONTH SKIP
AVAILABLE**

**NO PRE-PAYMENT
PENALTIES EVER!**

LOWEST DOWN PAYMENT
10% DOWN

4,99% Interest for as Long as 60-Months.

Payments as Low as
€1.698 PER MONTH

LOWEST INTEREST
0% FOR 48 MONTHS

Requires Larger Down Payment.

Payments as Low as
€1.042 PER MONTH

LONGEST TERM
84-MONTH TERM

With Rates as Low as 4,99%*

Payments as Low as
€707 PER MONTH

Sample payments are based on a €100.000 CNC machine purchase.

SAVE €8.099 IN INTEREST!

(Based on 0,00% for 36 months, compared to US Prime Lending Rate at 7.25% interest.)

HAE Marketing Update

INSANE FINANCING FOR YOUR NEXT HAAS CNC

DOWN PAYMENT	CHOOSE YOUR TERM						
	12-MONTHS	24-MONTHS	36-MONTHS	48-MONTHS	60-MONTHS	72-MONTHS	84-MONTHS
10% DOWN	0,00%	2,49%	3,49%	4,49%	4,99%	N/A	N/A
20% DOWN	0,00%	1,49%	2,49%	2,99%	4,49%	5,49%	5,99%
25% DOWN	0,00%	0,00%	1,49%	2,49%	3,49%	4,99%	5,49%
30% DOWN	0,00%	0,00%	0,00%	1,49%	2,99%	4,49%	4,99%
50% DOWN	0.00%	0.00%	0.00%	0,00%	2.99%	4.49%	4.99%
20% DOWN + 3-MO SKIP	1,49%	1,99%	2,99%	3,99%	5,49%	5,99%	6,49%
30% DOWN + 6-MO SKIP	1,99%	2,49%	3,49%	4,49%	N/A	N/A	N/A

Financing terms, conditions, and exceptions: valid in Denmark, Germany, France, Spain, Portugal, Belgium, Luxembourg, Estonia, Latvia, Lithuania, Czech Republic, Slovenia, Slovakia, and Greece only. References are to an implied interest rate under a conditional sales contract. Interest accrues during the skip period. Down payment, rate, and terms of financing are dependent upon credit approval. Eligible businesses should have three or more years of operation under current ownership. All programs are 10% - 50% down. Must put a minimum of 20% down to get no payments for 3 months. **Certain equipment (e.g., stand-alone Rotaries, Shop Equipment, Bar Feeders, etc.) are subject to different rates, terms, and down-payment requirements, unless financed with a machine. No prepayment penalty on any program. Monthly payment does not include applicable taxes, rigging, or freight charges.*

Offer valid on new machine orders placed from 1 October through 31 October 2025.

Did You Know...

Did You Know...



Welcome, **MSTEIN**

[Back](#) [Home » ATP Reports » US ATP Report](#)

US - ATP Report

Comments

Cobots (5KG/10KG/15KG/30KG): 3 weeks

UMC-1250/50: 5 weeks

HDC-3: December

HML-1 (Haas Manual Lathe): In Stock

EC-1600ZT PALLET POOL: 8 weeks

HAAS BAR FEEDER 12: November

HVS-1 (Haas Vertical Saw): November

HMS-3123 (Haas Miter Saw): November

SR-4020P: January

VS-3-5AX: 6 months

GM-1XT: 9 weeks

Always review notes in ATP comments section

HFL-3015-3, HFL-3015-6 (Haas Fiber Laser): February

SMTC-120 on UMC-750/750SS: December - 6 more machines with SMTC-120 can ship in 2025

SMTC-120 on UMC-500/500SS: December - 6 more machines with SMTC-120 can ship in 2025

SMTC-120 on VF-3/3SS/4/4SS: Q1 2026

SMTC-160 on EC-400/500: Q1 2026

10K Spindle on HDC-3-5AX: December

DC-3/40: 4 months

DC-4/40: 1 machine available in 4 weeks. 4 machines available in December.

SB-28/35/35L/35Y/35LY: February

COBOT PKG-20KG-F: December

GM: same lead time as GR

RPL-30KG: November

Did You Know...





Half Series – lightweight/lighter duty, affordable, readily available, serviceability

DETa-1 Collets
Metric Collets, 2.5 - 13mm
(0.098" - 0.511")



Special Tapping Sleeves
New sizes being added
(Max. M12 or 1/2")

Rotation: CCW=CW

BT & HSK will be added soon

 <p>Right-Angle CT40 Half-Series Drill/Mill Angle Head, Haas Toolholding by MST/Kitagawa Part #: 04-1822 \$2,695.95</p> <p>- 1 + Add</p>	 <p>Right-Angle CT40 Half-Series Tap Angle Head, Haas Toolholding by MST/Kitagawa Part #: 04-1823 \$2,795.95</p> <p>- 1 + Add</p>	 <p>Right-Angle CT40 Mini Half-Series Drill/Mill/Tap ER-11 Angle Head, Haas Toolholding by MST/Kitagawa Part #: 04-1845 \$3,299.95</p> <p>- 1 + Add</p>	 <p>New Sale ER11 9/32" Straight-Bore Collet, 0.281 - 0.262" Clamping Range Part #: 04-1367 \$19.97 \$23.95</p> <p>- 1 + Add</p>	 <p>New Sale ER11 8mm Straight-Bore Collet, 8 - 7.5mm Clamping Range Part #: 04-0290 \$13.97 \$16.95</p> <p>- 1 + Add</p>
--	---	---	--	---

Output Ratio **1:1**

 <p>Right-Angle 6mm DETa-1 Collet Part #: 04-1825 \$109.95</p> <p>- 1 + Add</p>	 <p>Right-Angle 8mm DETa-1 Collet Part #: 04-1826 \$109.95</p> <p>- 1 + Add</p>	 <p>Right-Angle #10 Tap Sleeve/Collet Part #: 04-1839 \$304.95</p> <p>- 1 + Add</p>	 <p>Right-Angle JIS M10 Tap Sleeve/Collet Part #: 04-1835 \$304.95</p> <p>- 1 + Add</p>
---	---	---	---

Output Ratio **1:0.88**



Reversible collet direction

- Factory Training Dates for 2025
 - December 3/4

Please email Scott Gasich directly with any names, email addresses and job functions for those who will be attending



THANK YOU!
FOR ALL YOUR EFFORTS



HMAS

