



**SALES AND MARKETING
UPDATE**



HMAS

September 2025



Topics

- Products and Price List
- Video
- Tooling
- Marketing
- Did You Know...

Products and Price List Update

Products and Price List Update

- HFL-3015 release in North America
- Release SIMULATOR-STD (15" monitor) in all regions. SIMULATOR-STD replaces SIMULATOR in all regions.
- Release SIMULATOR-PREMIUM (19" monitor) in all regions.
- SMTC-120 tool changer option added to VF-3, VF-3SS, VF-4, and VF-4SS in all regions
- SMTC-160 tool changer option added to EC-400 and EC-500 in all regions
- VOP-A-DS-20Y-25Y, VOP-B-DS-20Y-25Y, VOP-C-DS-20Y-25Y, and VOP-D-DS-20Y-25Y released in all regions except HE, CH, CN
- TSC-READY and TSC READY-3RD PARTY options added to GM-1 and GM-1XT in all regions.
- HSK-A63 and 15K-HSK-A63 options added to GM-2 in all regions.
- AUTO DOOR-MILL & EDGE SENSOR options added to DT-3 and DM-3 in all regions.

Products and Price List Update

- HFL-3015 release in North America

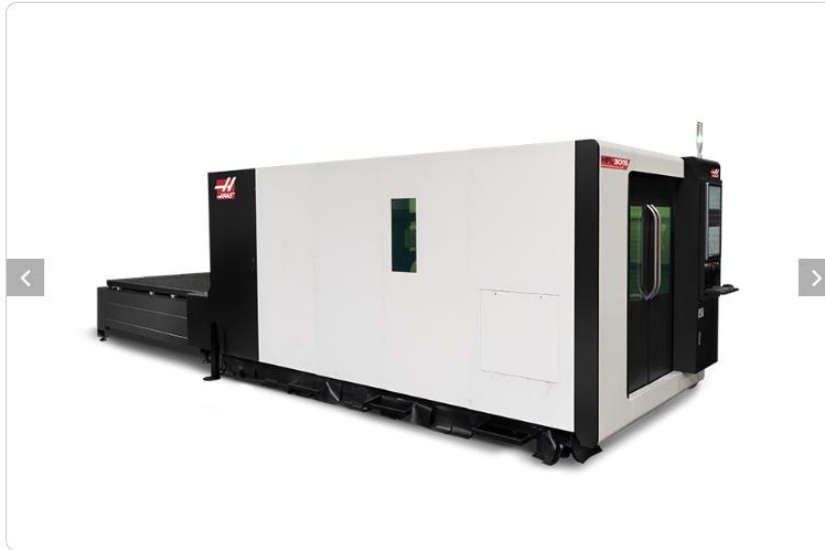

HFL-3015 Fiber Laser

Starting Price: **US\$149,995**



- 3 kW fiber laser
- 120" x 60" (3050 x 1530 mm) work area
- High-speed autofocus sensor head
- Programmable assist gas ports (air, oxygen, nitrogen)
- Dual automatic shuttle tables
- Windows-based laser controller w/large touchscreen
- CypCut laser programming software with nesting capability
- Internal and external cameras for process/safety monitoring
- Remote pendant
- Full enclosure for safety and protection
- Heat-isolated machine bed for stability
- Negative pressure dust removal system

The Haas HFL-3015 is a fully enclosed 3 kW CNC fiber laser cutting machine with a high-speed autofocus sensor head and a large work area. The unit has dual shuttle tables that exchange automatically, allowing raw material and finished parts to be loaded and unloaded on one table, while the other table is in the machine, providing near continuous operation.

The 3 kW fiber laser cutting head is optimized to provide excellent cut quality and high efficiency, and features automatic focusing to reduce set-up time and increase accuracy. The laser easily cuts a variety of metals, including carbon steel, stainless steel, aluminum alloy, brass, copper, and even titanium alloy.

MATERIAL CUTTING RANGE

MATERIAL	SAE	METRIC
Carbon Steel	0.016" - 0.78"	0.4 - 19.8 mm
Stainless Steel	0.016" - 0.47"	0.4 - 11.9 mm
Aluminum	0.016" - 0.31"	0.4 - 7.9 mm
Brass	0.016" - 0.23"	0.4 - 5.95 mm

NOTE: Maximum cutting range varies with material thickness, type of assist gas used, part geometry, cutting speeds, and desired cut quality.

Available to order in North America only, with expected delivery Q1 2026.

Products and Price List Update

- Release SIMULATOR-STD (15" monitor) in all regions. SIMULATOR-STD replaces SIMULATOR in all regions.



Control Simulator, Standard

Starting Price: US\$2,095

OVERVIEW

The Haas Standard Control Simulator is perfect for classroom training and on-site control demonstrations. Teach programming and machine operation using a real, full-function Haas control panel and keypad. Includes simulated graphic dry run, tool length measurement, work offsets, true DNC, and the Haas Visual Programming System. The standard control simulator also can be mirrored on a computer or mobile device, and projected for classroom display.

- ✓ Lightweight design
- ✓ 15" monitor
- ✓ Built-in USB, Ethernet, and WiFi connectivity
- ✓ Haas Visual Programming System
- ✓ Mill and lathe control software

Products and Price List Update

- Release SIMULATOR-PREMIUM (19" monitor) in all regions.



Control Simulator, Premium

Starting Price: US\$2,095

OVERVIEW

The Haas Premium Control Simulator is perfect for classroom training and on-site control demonstrations. Teach programming and machine operation using a real, full-function Haas control panel and keypad. Includes simulated graphic dry run, tool length measurement, work offsets, true DNC, and the Haas Visual Programming System. The premium control simulator also can be mirrored on a computer or mobile device, and projected for classroom display.

- ✓ Lightweight design
- ✓ 19" high-resolution touchscreen monitor
- ✓ Built-in USB, Ethernet, and WiFi connectivity
- ✓ Haas Visual Programming System
- ✓ Mill and lathe control software

Products and Price List Update

- SMTTC-120 tool changer option added to VF-3, VF-3SS, VF-4, and VF-4SS in all regions

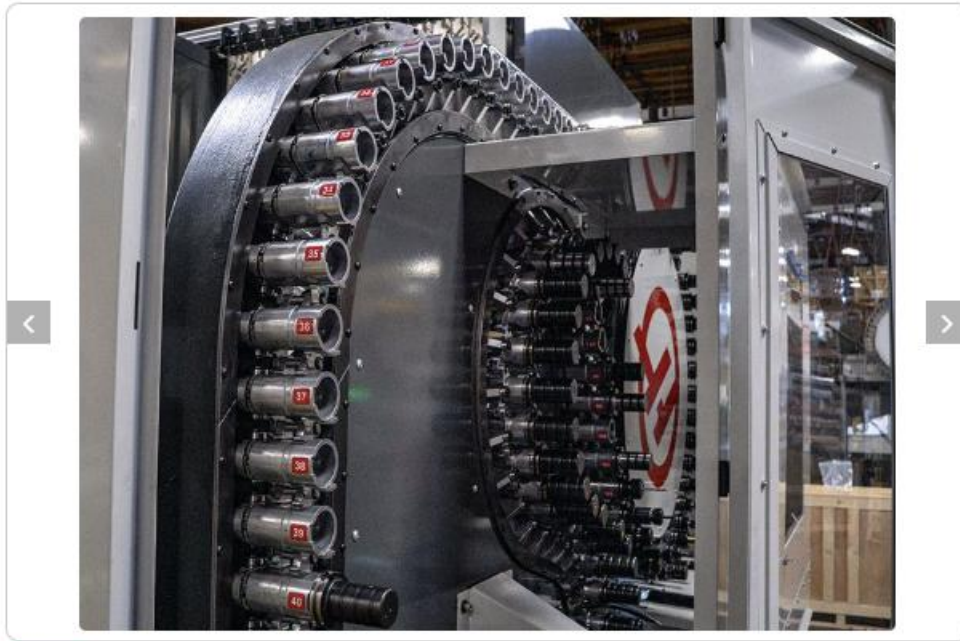

High-Speed 120+1 Side-Mount Tool Changer

Starting Price: **US\$69,995**

High-production tool changer for UMCs

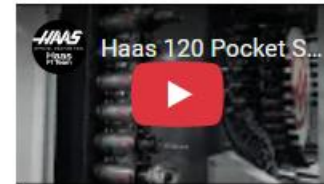

- Remote load station with automatic lockout
- Bi-directional servo-driven positioning for fast tool staging
- Mounts to the machine's bridge and base for stability
- High-speed tool changes reduce non-cutting time
- Tool Table allows complete control over the tool changer
- Identify tools as LARGE to leave adjacent pockets empty
- Identify tools as HEAVY to slow tool changer motion

120+1
TOOLS

40
TAPER

Side-Mount
TYPE

Estimated delivery for UMC-500SS: December 2025.
Estimated delivery for VF-3SS and VF-4SS: Q1 2026.

Products and Price List Update

- SMTC-160 tool changer option added to EC-400 and EC-500 in all regions



160+1 Side-Mount Tool Changer

Starting Price: **US\$99,995**

High-production tool changer for the EC-400 and EC-500

160+1
TOOLS

40
TAPER





Side-Mount
TYPE

Available for order, with estimated delivery Q1 2026.

Products and Price List Update

- VOP-A-DS-20Y-25Y, VOP-B-DS-20Y-25Y, VOP-C-DS-20Y-25Y, and VOP-D-DS-20Y-25Y released in all regions except HE, CH, CN

VALUE OPTION PACKAGES

 <p>VOP A - BASIC PACKAGE US\$119/mo DETAILS > SALE • US\$6,995 US\$7,995</p>	 <p>VOP B - PRODUCTIVITY PACKAGE US\$272/mo DETAILS > SALE • US\$15,995 US\$20,995</p>
 <p>VOP C - HIGH-PRESSURE COOLANT PACKAGE US\$407/mo DETAILS > SALE • US\$23,995 US\$32,495</p>	 <p>VOP D - BAR FEEDER READY PACKAGE US\$441/mo DETAILS > SALE • US\$25,995 US\$34,995</p>

Products and Price List Update

- TSC-READY and TSC READY-3RD PARTY options added to GM-1 and GM-1XT in all regions.

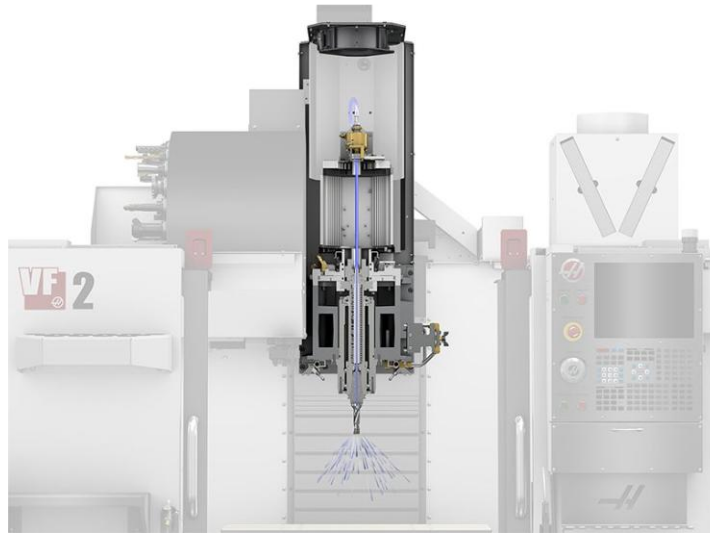

Through-Spindle Coolant Ready, 3rd Party

Starting Price: **US\$4,795**

Allows easy field installation of a 3rd-party TSC system

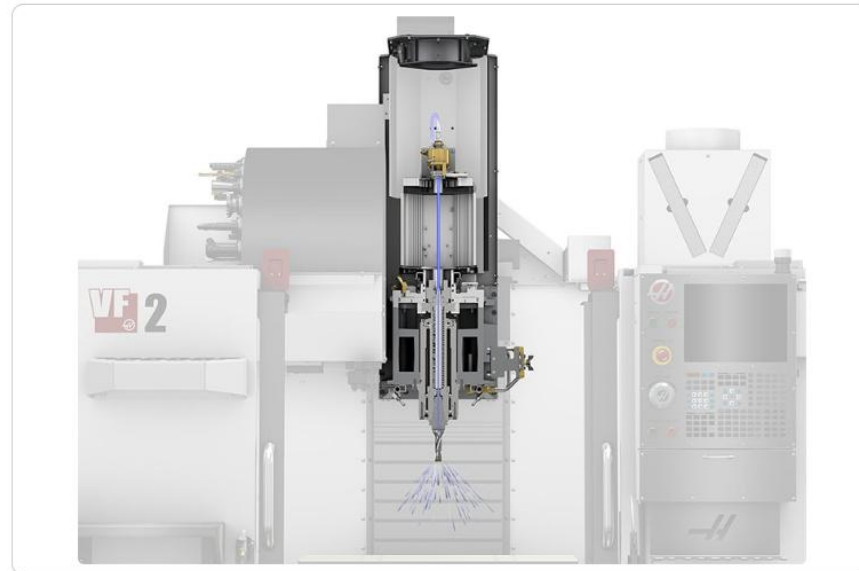

Through-Spindle Coolant Ready

Starting Price: **US\$1,395**

Allows easy field installation of a Haas TSC system

Products and Price List Update

- HSK-A63 and 15K-HSK-A63 options added to GM-2 in all regions.

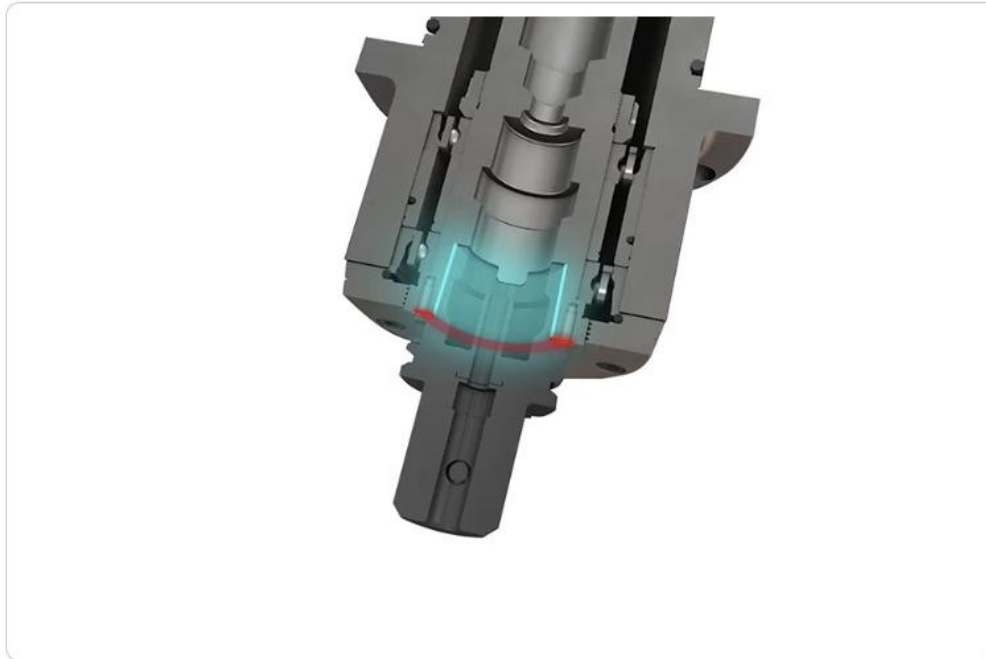

15,000-rpm Spindle, HSK-A63

Starting Price: **US\$17,595**

HSK spindle for UMC, VF, and VM series

GM-2 Added

15k
SPEED

HSK-A 63
TAPER

30 hp
POWER

Inline
DRIVE

Tooling Taper (BT/CT)

BT
BT option

Required

CT
CT option

Required

HSK-A63
HSK-A63 Spindle Taper

Added

Required

Products and Price List Update

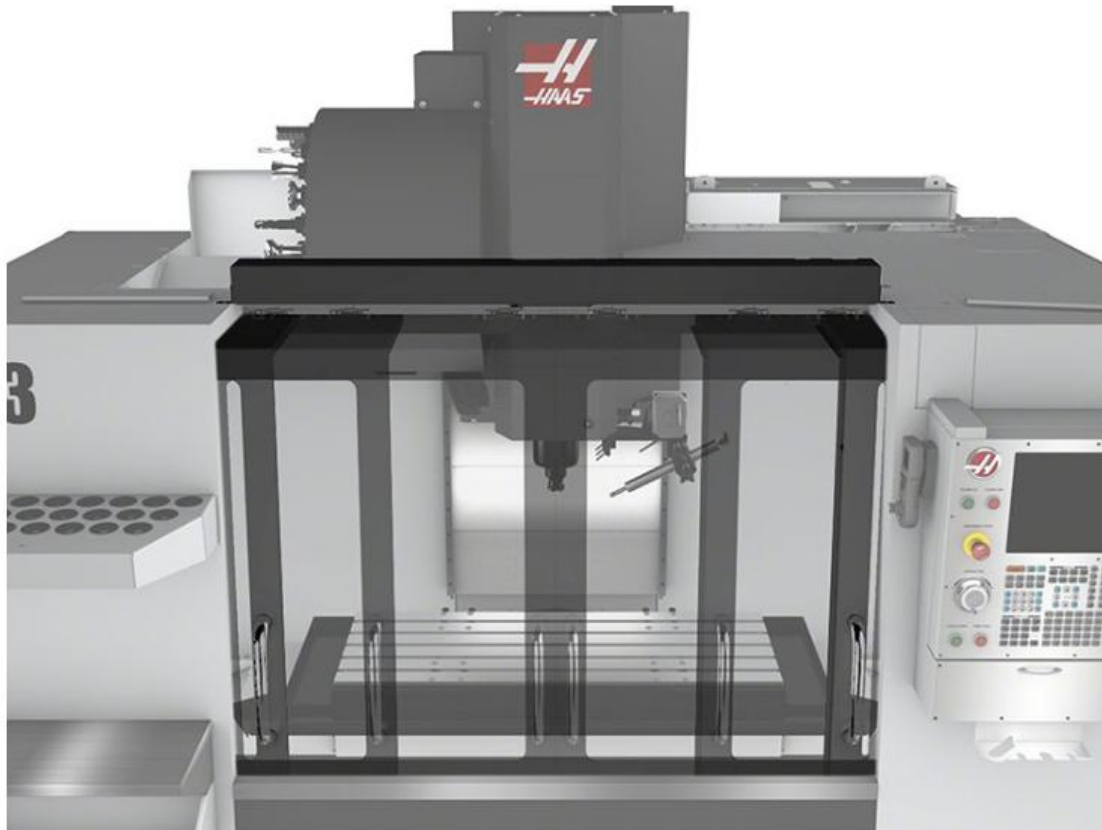

- AUTO DOOR-MILL & EDGE SENSOR options added to DT-3 and DM-3 in all regions.



Auto Door for Mills

Starting Price: **US\$2,395**

Increases productivity and reduces operator fatigue

	AUTO DOOR FOR MILLS WATCH VIDEO >	US\$41/mo US\$2,395		AUTO WINDOW DETAILS >	US\$58/mo US\$3,395
---	--	------------------------	---	--	------------------------

Video Update

Video Update

Recently Released Videos

- Haas Mill Table Washdown Tool - HaasTooling.com - <https://www.youtube.com/watch?v=0gVBsPD1xI0&t=2s>
- Precision Digital Levels at HaasTooling.com - Haas Automation, Inc. - <https://www.youtube.com/watch?v=FINYzIjYBtc>
- Haas Multi-Stage Coolant Pump and Chip Washdown Feature - Haas Automation, Inc. - <https://www.youtube.com/watch?v=Y4i2jDULMLA>
- Haas TL-1P - Run Production with Your Toolroom Lathe - Haas Automation, Inc. – https://www.youtube.com/watch?v=9ezTpJ_SCSg
- Customer Spotlight - MF Tool & Design - Haas Automation, Inc. – <https://www.youtube.com/watch?v=XtqpXGUBSnw>

Video Update

Recently Released Videos

- Haas Mill Table Washdown Tool - HaasTooling.com - <https://www.youtube.com/watch?v=0gVBsPD1xI0&t=2s>

Haas Tooling Video

- Informative video
- Works with 300 & 1000 psi
- VPS Template driven
- Perfect for Automation
- Super Affordable
- Check it out
- Share it as needed



Video Update

Recently Released Videos

- Precision Digital Levels at HaasTooling.com - Haas Automation, Inc. - <https://www.youtube.com/watch?v=FINYzIjYBtc>

Haas Tooling Video

- Informative video
- Time Saving Tool
- Simple Operation
- Check it out
- Share it as needed



Video Update

Recently Released Videos

- Haas Multi-Stage Coolant Pump and Chip Washdown Feature - Haas Automation, Inc. - <https://www.youtube.com/watch?v=Y4i2jDULMLA>

Machine Feature Video

- Enhanced Feature
- Solves a common problem
- Assists with Automation
- Improves operator efficiency
- Retrofittable to existing machines
- Check it out
- Share it as needed



Video Update

Recently Released Videos

- Haas TL-1P - Run Production with Your Toolroom Lathe - Haas Automation, Inc. – https://www.youtube.com/watch?v=9ezTpJ_SCSg

Sizzle Video

- Low Level Production
- Great for second op machine
- Improved Performance
 - Better Chip Control
 - Less Vibration
 - Increased Tool Life
 - Better Finishes
 - Improved Productivity
- Great Intro Video
- Check it out
- Share it as needed



Video Update

Recently Released Videos

- Customer Spotlight - MF Tool & Design - Haas Automation, Inc. – <https://www.youtube.com/watch?v=XtqpXGUBSnw>

Customer Spotlight Video

- From Toolroom to 5 Axis
- Gains competitive edge
- Improved capability
- 3+2 Machining
- True 5-Axis Machining
- Embracing Unattended Machining
- Check it out
- Share it as needed



Tooling Update

Tooling Update

New Site

- Faster
- More Powerful
- New Look
- Improved User Experience

The screenshot shows the Haas Tooling website interface. At the top, there is a navigation bar with the Haas Tooling logo, a search bar, and links for 'Find Your Distributor', 'Quick Order', and 'Sign In'. Below the navigation bar, there are menu items for 'TOOLING', 'PROMOTIONS', 'WHY HAAS TOOLING', and 'SERVICE PARTS'. A large banner features the text 'NEW SITE SALE STARTS NOW! UP TO 30% OFF' and 'New Site, Same Great Deals. Over 4800+ Tools on Sale.' with a 'Shop Now' button. Below the banner, a section titled 'Most Popular Categories' displays six product categories with their respective product counts: Solid Carbide End Mills (477 products), End Mill Holders (106 products), ER Collet Chucks (90 products), Carbide Drills (811 products), Taps (460 products), and Tooling Accessories (484 products). A 'Shop All Categories' section follows, with the text 'Your one-stop shop for tooling. Explore categories for mills, lathes, inspection, workholding, and more.' Below this, there are six more category tiles: Winner's Circle (1 product), Shop Support (34 products), Automation Accessories (61 products), Tool Management (40 products), Measuring & Inspection (470 products), and Mill Toolholding (500 products).

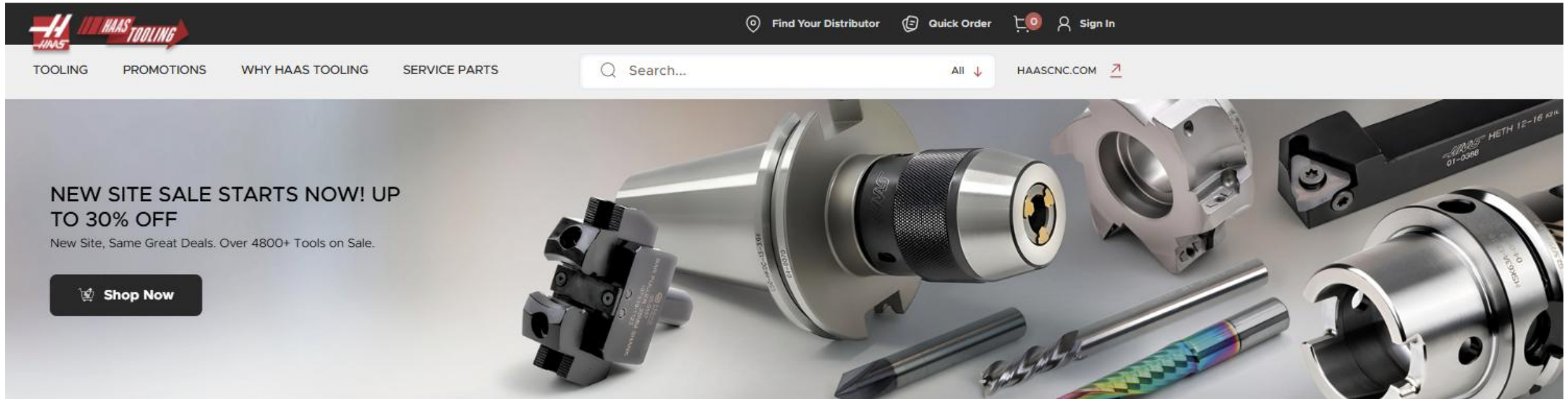

WINNER'S CIRCLE Update

Still On Sale - Only \$10 – 90% off the already reduced price

Over 16,000 Subscriptions and Growing

Update on Tooling Margins

View published

New draft

Moderate

Track

Devel

Submitted by *pbeswick* on Mon, 2025-08-18 08:16

Haas Tooling is **REMOVING THE 10% MARGIN CAP on On-Sale Tooling items, effective Monday, August 18.**

This means that you can achieve full margin whether an item is on-sale or not, which should result in richer margins for your HFO on Tooling.

The new Dealer Margin structure is as simple as this:

Tooling Orders **Under \$5K or €5K: 15% margin**

Tooling Orders **Over \$5K or €5K: 20% margin**

Shop support machines like Air Compressors, tool Presetters, Heat Shrinks, CMMs and Laser Markers are still 10% margin, but still margin-rich due to their higher price-points.

Beyond the above points, there are no margin restrictions for orders with on-sale items.

Our goal with this change is to support your efforts to sell more Tooling by earning richer margins. In the unlikely event that this does not result in an increase in Tooling sales we may have to re-evaluate these margins again at the end of the year.

Thanks and please reach out with any questions.

**Update on Tooling
Margins**

2 weeks 6 days ago

Tooling Update, Global Except Europe & China



Hardness Tester

1



Portable EDM

1



Machine Additives & Supplies

3



Mill Table Washdown Tools & Kits

23



Zero Point System

11



Micrometer Accessories

5

+27 Items

- Digital Rockwell Hardness Tester
- Portable EDM Tap Remover
- Grease Gun
- Haas Parts Washer Tool Kit
- Zero Point System Kits
- Telescoping Gauge set

NEW SITE SALE STARTS NOW! UP
TO 30% OFF

New Site, Same Great Deals. Over 4800+ Tools on Sale.

 [Shop Now](#)

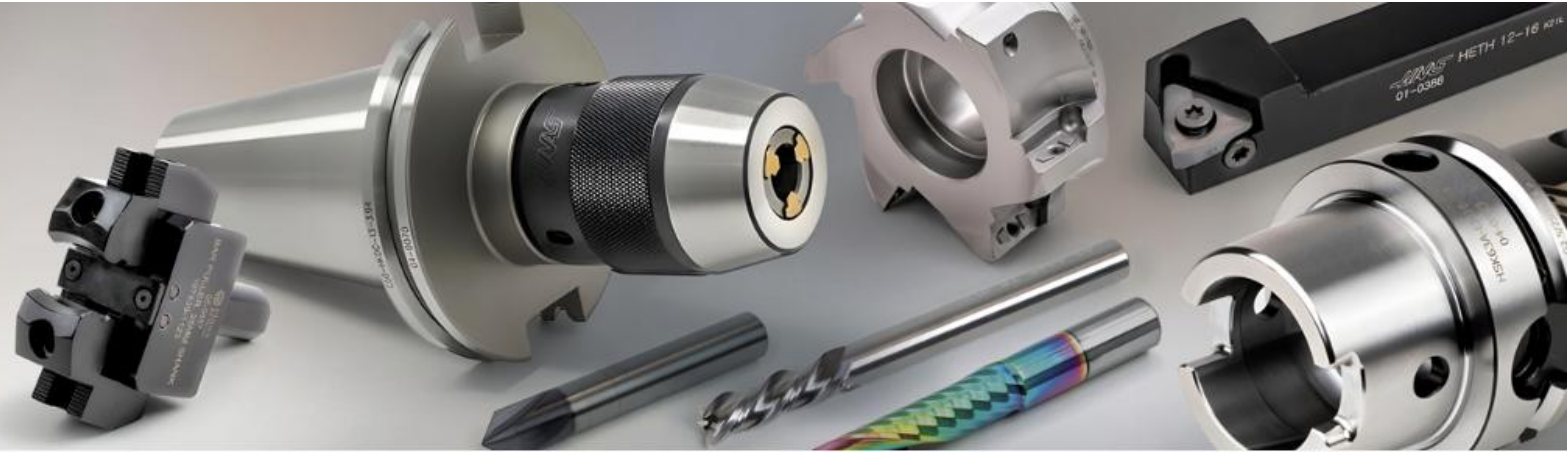

WINNER'S CIRCLE Update

Still On Sale - Only €10 – 90% off the already reduced price

Over 16,000 Subscriptions and Growing

HAE - Tooling Update

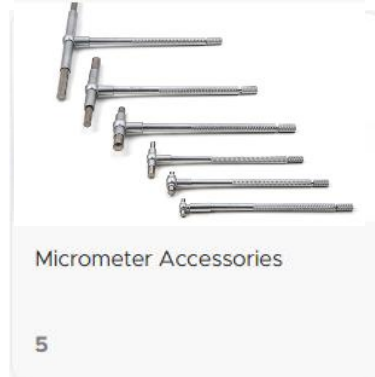
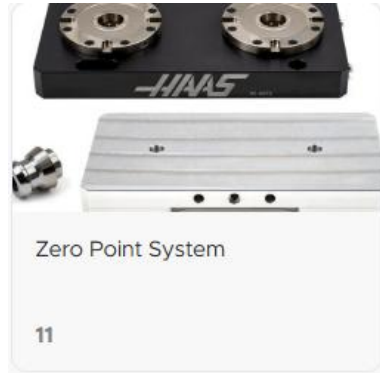

+20 Items

- Haas Parts Washer Tool Kit
- Zero Point System Kits
- Telescoping Guage set

Marketing Update

SAVE 10% ON ANY DC-1 OR 2



& GET A FREE ROTARY TABLE



LEARN MORE

CHOOSE FROM AN HA5C, HRT160 or HRT210

NEW SITE SALE



FREE 
NEXT-DAY DELIVERY

SIGN UP FOR WINNER'S CIRCLE
\$10 FOR A YEAR! (~~\$95~~)

SHOP HAAS TOOLING

SECTION 179
**TAX SAVINGS
FOR 2025**



**NO PAYMENTS
UNTIL 2026!**

LEARN MORE

HAAS
KNEE MILL & MANUAL LATHE
BUY THEM TOGETHER



AND
SAVE 10%

LEARN MORE

VOP

VALUE OPTION PACKAGES
**A NEW WAY
TO SAVE**

LEARN MORE

SAVE 10% ON ANY DC-1 OR 2



& GET A FREE ROTARY TABLE



LEARN MORE **CHOOSE FROM AN HA5C, HRT160 or HRT210**

**STOCK
SALE**

**IN-STOCK & READY
TO SHIP!**

LEARN MORE

**NEW
SITE
SALE**



**UP TO
30%
OFF!**

HAAS HAAS TOOLING

FREE NEXT-DAY DELIVERY

SIGN UP FOR WINNER'S CIRCLE
\$10 FOR A YEAR! (\$95)

SHOP HAAS TOOLING



HOT DEALS

In-Stock and Ready-to-Ship Machines

Haas Hot Deal Machines are brand-new machines in stock with special pricing. These machines are currently in our inventory, and ready for immediate delivery. All Hot Deal Machines come with a full standard 1-year warranty.

[SEE DEALS](#)



DEMO & PREOWNED

Pre-owned Machines - Most pre-owned machines were used for training new machinists at schools and technical education centers and are sold as-is, with no warranty.

Demo Machines - New machines that had limited usage performing test cuts for the purpose of demonstrating the machine capabilities. Sold with a full 1-year warranty.

[VIEW MACHINES](#)



CANCELED ORDERS

Brand-New, Custom Configured Machines

Never Used!
Canceled orders, fully inspected, and ready to ship with a standard 1-year warranty. These machines have never been installed, so don't miss out on these custom configured options at unbeatable prices!

[VIEW MACHINES](#)



Hot Deals – 15% to 30% Off
Demo Machines – 15% to 30% Off
Canceled Orders – 25% to 30% Off

Marketing Tools

View Edit Track Devel

*** All images are clickable ***



HAAS TOOLING HOME PAGE

[Haas Tooling Promo page](#)

[How to redeem Online Tooling Promos](#)

2025 AVAILABLE DIGITAL MARKETING CAMPAIGNS and MODEL GUIDES, PDFs, CATALOGS

*Check Marketing Campaign page for info about HFO Demo Day.

Tooling Kits Explained (08/PCK/EK)

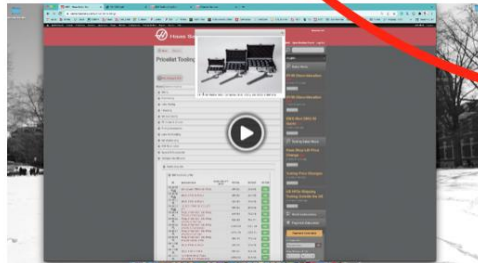

FINANCING RATES *NEW

CNCA Financing Rates are **Extended to September 30, 2025.**

Available for: US, Canada, HAE (Denmark, Germany, France, Spain, Portugal), Belgium, Luxembourg, Estonia, Latvia, Lithuania, Czech Republic, Slovenia, Slovakia, and Greece)

Date updated: August 29, 2025

Rates Chart #

Rate Factors for CNCA Finance for USA, Canada, & HAE - July 2025 job JM - like HFO Blend (Shared) is 1% of the financed amount Effective Sept 1, 2025 Changed from Aug 2025

Term	12 Months		Months				
	12	36	36	48	60	72	84
10%	0.00%	2.00%	4.49%	4.49%	4.49%	4.49%	4.49%
20%	0.00%	1.00%	3.49%	3.49%	3.49%	3.49%	3.49%
25%	0.00%	0.00%	2.49%	2.49%	2.49%	2.49%	2.49%
30%	0.00%	0.00%	0.00%	0.00%	0.00%	0.00%	0.00%
35%	1%	1.00%	1.99%	1.99%	1.99%	1.99%	1.99%
35%	1%	1.99%	2.00%	2.00%	2.00%	2.00%	2.00%

RATE FACTORS

Term	12 Months		Months				
	12	36	36	48	60	72	84
10%	0.00000	0.00276	0.02000	0.02000	0.02000	0.02000	0.02000
20%	0.00000	0.00000	0.02000	0.02000	0.02000	0.02000	0.02000
25%	0.00000	0.00000	0.02000	0.02000	0.02000	0.02000	0.02000
30%	0.00000	0.00000	0.02000	0.02000	0.02000	0.02000	0.02000
35%	0.00000	0.00000	0.02000	0.02000	0.02000	0.02000	0.02000
35%	1%	0.00000	0.02000	0.02000	0.02000	0.02000	0.02000
35%	1%	0.00000	0.02000	0.02000	0.02000	0.02000	0.02000

RATES CHART

2025 CNCA Payment Calculator #

Term	Down Payment	12 Months	24 Months	36 Months	48 Months	60 Months	72 Months	84 Months
10% Down	\$ 25,000.00	\$ 2,000.00	\$ 2,000.00	\$ 2,000.00	\$ 2,000.00	\$ 2,000.00	\$ 2,000.00	\$ 2,000.00
20% Down	\$ 20,000.00	\$ 1,600.00	\$ 1,600.00	\$ 1,600.00	\$ 1,600.00	\$ 1,600.00	\$ 1,600.00	\$ 1,600.00
30% Down	\$ 15,000.00	\$ 1,200.00	\$ 1,200.00	\$ 1,200.00	\$ 1,200.00	\$ 1,200.00	\$ 1,200.00	\$ 1,200.00
40% Down	\$ 10,000.00	\$ 800.00	\$ 800.00	\$ 800.00	\$ 800.00	\$ 800.00	\$ 800.00	\$ 800.00
50% Down	\$ 5,000.00	\$ 400.00	\$ 400.00	\$ 400.00	\$ 400.00	\$ 400.00	\$ 400.00	\$ 400.00
60% Down	\$ 0.00	\$ 0.00	\$ 0.00	\$ 0.00	\$ 0.00	\$ 0.00	\$ 0.00	\$ 0.00

CNCA PAYMENT CALCULATOR - EXCEL FILE

Rates PDF for US Customers #
(Updated August 29, 2025)

Rates PDF for HAE Customers #
(Updated August 29, 2025)

US CUSTOMER FINANCING PDF **HAE Customer Financing PDF**

Marketing Update

2025 AVAILABLE DIGITAL MARKETING CAMPAIGNS + MODEL GUIDES/PDFS/CATALOGS

These campaigns will be running throughout 2025. Email HFOEmailSupport@haascnc.com if you want to have Haas email your customer base regarding any of the below campaigns.

CURRENT LIVE MARKETING CAMPAIGNS

NEW Marketing Campaigns added

- **120-Pocket Side-Mount Tool Changer** *NEW
- **Mill-Spindle C-Axis** *NEW
- **Knee Mill** *NEW
- **Box Way Lathe** *NEW
- **HFL-3015 Fiber Laser** *NEW
- **DMs/DTs** *NEW
- **Hot Deals on In-Stock Machines** *NEW
- **Financing Rates** *NEW
- **SR-3015 Sheet Router** *NEW
- **HFO Demo Day** *NEW
- **DC-Series** *NEW
- **GM-1 Gantry Mills** *NEW

NEW Sales

- **Flash Sale** *NEW
- **Hot Deals on In-Stock Machines** *NEW
- **Value Option Packages (VOP)** *NEW

Ongoing Marketing Campaigns Available

- EU Models *(update coming soon)*
- Mini Mill Redesign
- Rotaries
- Customer Testimonials
- Showroom Machines/Local Inventory
- Energy Savings
- New to CNC
- New to Haas
- Advanced Haas User
- Industry – Aerospace
- Industry – Firearms
- Industry – Medical/Dental
- Haas Makes It Easy
- Why Haas
- First-Time Buyers
- Small Footprint
- Affordable Machines
- Most Popular Machine
- Robot Competition
- Most Popular Machine
- Fully Integrated Pallet Pools
- Why Buy a Robot
- Trade In, Trade Up
- Machine Highlight
- Small VF
- EC-400
- VC-400
- UMC-500
- 50-Taper
- ST-28Y
- VF-2YT Series Pallet Pool

TOOLING MARKETING CAMPAIGNS

- **Haas Cobot** *NEW
- Benefits of Haas Tooling
- Haas Workholding by Kurt
- Ready2Run
- Ready2Machine

PDFS/CATALOGS/MODEL GUIDES

Available in Multiple Languages

- **Haas Journal** *NEW
- **Model Guides** *NEW
- **Shop Notes** *NEW
- EU Series PDFs
- Haas Tooling Winner's Circle Introduction Flyer
- Haas Tooling Winner's Circle Letter
- Haas Tooling Winner's Circle Poster
- Haas Tooling 4 Pagers
- Haas Tooling Catalog
- Haas Guide to Automation: Robots
- V-Model PDFs
- Catalog on Haas Automated Systems

HFO EVENTS

Fill out the survey below to start the process of getting marketing materials created for your event. You must submit the survey a minimum of 2 months before your event. *Date updated: Jan 2025*

[EVENT SURVEY](#)

**Click here for the Demo Day survey and marketing materials.*

Marketing Update

Rate Factors for CNCA Promos for USA, Canada, & HAE - July 2025 pb JM .xlsx

HFO Blind Discount is 1% of the financed amount

Effective Sept 1, 2025		Changed from Aug 2025						
	Skip Days	Months						
Term		12	24	36	48	60*	72**	84* **
10%		0.00%	2.49%	3.49%	4.49%	4.99%		
20%		0.00%	1.49%	2.49%	2.99%	4.49%	5.49%	5.99%
25%		0.00%	0.00%	1.49%	2.49%	3.49%	4.99%	5.49%
30%		0.00%	0.00%	0.00%	1.49%	2.99%	4.49%	4.99%
50%		0.00%	0.00%	0.00%	0.00%	2.99%	4.49%	4.99%
20%	90	1.49%	1.99%	2.99%	3.99%	5.49%	5.99%	6.49%
30%	180	1.99%	2.49%	3.49%	4.49%			

		RATE FACTORS						
Term		12	24	36	48	60*	72**	84* **
10%		0.08333	0.04276	0.02930	0.02280	0.01887		
20%		0.08333	0.04232	0.02886	0.02213	0.01864	0.01634	0.01461
25%		0.08333	0.04167	0.02842	0.02190	0.01819	0.01611	0.01437
30%		0.08333	0.04167	0.02778	0.02147	0.01797	0.01587	0.01413
50%		0.08333	0.04167	0.02778	0.02083	0.01797	0.01587	0.01413
20%	90	0.08422	0.04268	0.02923	0.02273	0.01928	0.01674	0.01501
30%	180	0.08494	0.04321	0.02973	0.02323			

VALUE OPTION PACKAGES

PROMOTIONS

NEW PRODUCTS

GENERAL & MACHINE

TOOLING

PDFS AND BROCHURES

NEW PRODUCT MARKETING CAMPAIGNS

- ✓ Pocket Mill
- ✓ DS Lathe Series
- ✓ Band Saw
- ✓ Air Compressor
- ✓ Laser Marker
- ✓ CMM
- ✓ Surface Grinder
- ✓ 120-Pocket Side-Mount Tool Changer
- ✓ Mill-Spindle C-Axis
- ✓ Knee Mill
- ✓ UMC-400/SS
- ✓ DMs/DTs
- ✓ TL-P
- ✓ ST-40 Updates (short/long/Y-axis)
- ✓ EC-1600ZT + 4+1 Pallet Pool
- ✓ DC Series
- ✓ SB Series
- ✓ SR-3015 and SR-3015P Sheet Router
- ✓ Robotic Pallet Loader
- ✓ Mini Max
- ✓ HFL-3015 Fiber Laser
- ✓ GM-1 Series

***More New Machines Coming Soon!**

CNCA FINANCING PRESENTS:

CHOOSE YOUR OWN
FINANCING

<p>LOWEST DOWN PAYMENT</p> <p>10% DOWN 4.99% INTEREST FOR 60-MONTHS.</p> <p>PAYMENTS AS LOW AS \$1,698 PER MONTH</p>	<p>LOWEST INTEREST</p> <p>0% FOR 48 MONTHS REQUIRES LARGER DOWN PAYMENT</p> <p>PAYMENTS AS LOW AS \$1,042 PER MONTH</p>	<p>LONGEST TERM</p> <p>84-MONTH TERM WITH RATES AS LOW AS 4.99*</p> <p>PAYMENTS AS LOW AS \$707 PER MONTH</p>
--	---	---

SAMPLE PAYMENTS ARE BASED ON A \$100,000 CNC MACHINE PURCHASE.

SAVE \$8,388 IN INTEREST!
(BASED ON 0.00% FOR 36 MONTHS, COMPARED TO PRIME RATE AT 7.5% INTEREST)

NO PRE-PAYMENT PENALTIES EVER!

UP TO 6-MONTH SKIP AVAILABLE

Haas F1 Team
OFFICIAL MACHINE TOOL

Haas Automation, Inc.
2800 Sturgis Rd., Dixon, CA, USA, +1-805-278-1800
Haas Automation Europe
Mercuriusstraat 28, B-1930 Zaventem, Belgium
Specifications subject to change without notice. Not responsible for typographical errors. Machines shown with optional equipment. Actual product appearance may differ. Pricing subject to change without notice.

INSANE FINANCING FOR YOUR NEXT HAAS CNC

DOWN PAYMENT	CHOOSE YOUR TERM						
	12-MONTHS	24-MONTHS	36-MONTHS	48-MONTHS	60-MONTHS	72-MONTHS	84-MONTHS
10% DOWN	0.00%	2.49%	3.49%	4.49%	4.99%	N/A	N/A
20% DOWN	0.00%	1.49%	2.49%	2.99%	4.49%	5.49%	5.99%
25% DOWN	0.00%	0.00%	1.49%	2.49%	3.49%	4.99%	5.49%
30% DOWN	0.00%	0.00%	0.00%	1.49%	2.99%	4.49%	4.99%
50% DOWN	0.00%	0.00%	0.00%	0.00%	2.99%	4.49%	4.99%
20% DOWN + 3-MO SKIP	1.49%	1.99%	2.99%	3.99%	5.49%	5.99%	6.49%
30% DOWN + 6-MO SKIP	1.99%	2.49%	3.49%	4.49%	N/A	N/A	N/A

* Financing Terms, Conditions, and Exceptions: References are to an implied interest rate under a conditional sales contract. Interest accrues during the skip period. Down payment, rate, and terms of financing are dependent upon credit approval.

Eligible businesses should have three or more years of operation under current ownership. **U.S. and Canada only.**

All programs are 10% - 50% down. Must put a minimum of 20% down to get no payments for 3 months. Monthly payment does not include applicable taxes, rigging, or freight charges.

Certain equipment (e.g., stand-alone Rotaries, Shop Equipment, Bar Feeders, etc.) are subject to different rates, terms, and down-payment requirements, unless financed with a machine. No prepayment penalty on any program. Not responsible for misprints or typographical errors. Offer valid on new machine orders placed from **September 1 through September 30, 2025.**

INSANE FINANCING FOR YOUR NEXT HAAS CNC

DOWN PAYMENT	CHOOSE YOUR TERM						
	12-MONTHS	24-MONTHS	36-MONTHS	48-MONTHS	60-MONTHS	72-MONTHS	84-MONTHS
10% DOWN	0.00%	2.49%	3.49%	4.49%	4.99%	N/A	N/A
20% DOWN	0.00%	1.49%	2.49%	2.99%	4.49%	5.49%	5.99%
25% DOWN	0.00%	0.00%	1.49%	2.49%	3.49%	4.99%	5.49%
30% DOWN	0.00%	0.00%	0.00%	1.49%	2.99%	4.49%	4.99%
50% DOWN	0.00%	0.00%	0.00%	0.00%	2.99%	4.49%	4.99%
20% DOWN + 3-MO SKIP	1.49%	1.99%	2.99%	3.99%	5.49%	5.99%	6.49%
30% DOWN + 6-MO SKIP	1.99%	2.49%	3.49%	4.49%	N/A	N/A	N/A

YOUR NEXT HAAS CNC

DOWN PAYMENT	CHOOSE YOUR TERM						
	12-MONTHS	24-MONTHS	36-MONTHS	48-MONTHS	60-MONTHS	72-MONTHS	84-MONTHS
10% DOWN	0.00%	1.99%	2.99%	3.99%	4.49%	N/A	N/A
20% DOWN	0.00%	0.99%	1.99%	2.49%	3.99%	4.99%	5.49%
25% DOWN	0.00%	0.00%	0.99%	1.99%	2.99%	4.49%	4.99%
30% DOWN	0.00%	0.00%	0.00%	0.99%	2.49%	3.99%	4.49%
40% DOWN	N/A	N/A	N/A	0.00%	N/A	N/A	N/A
20% DOWN + 3-MO SKIP	N/A	1.49%	1.99%	3.49%	4.99%	5.49%	5.99%
30% DOWN + 6-MO SKIP	N/A	1.99%	2.49%	3.99%	N/A	N/A	N/A

EMO
HANNOVER
22-26/09/2025

SALE

UMC 500

LEARN MORE

NEW SITE SALE

UP TO 50% OFF!

HAAS TOOLING

FREE EXPRESS DELIVERY

SIGN UP FOR WINNER'S CIRCLE
€10 FOR A YEAR! (€95)

SHOP HAAS TOOLING

Machines Configured Exclusively for Europe

EU SERIES: UP TO 34% OFF

MORE CHOICES, MORE VALUE - JUST FOR EUROPE

LEARN MORE

HAE Marketing Update

SAVE 10% ON ANY DC-1 OR 2



& GET A FREE ROTARY TABLE



CHOOSE FROM AN HA5C, HRT160 or HRT210

EMO HANNOVER
22-26/09/2025

SALE



NEW SITE SALE

UP TO **50% OFF!**



FREE EXPRESS DELIVERY SIGN UP FOR WINNER'S CIRCLE **€10 FOR A YEAR!** (€95)



STOCK SALE

IN STOCK & READY TO SHIP

Brand-New Hot Deals, Demo, Pre-Owned Machines, and more!

EU-SERIES



Haas Lathes & Vertical Mills.
More Choices. More Value.

HAE Marketing Update

- Haas Automation -

STOCK SALE

HOT DEALS

In-Stock and Ready-to-Ship Machines

Haas Hot Deal Machines are brand-new machines in stock with special pricing. These machines are currently in our inventory, and ready for immediate delivery. All Hot Deal Machines come with a full standard 1-year warranty.

SEE DEALS



DEMO & PREOWNED

Pre-owned Machines – Most pre-owned machines were used for training new machinists at schools and technical education centers and are sold as-is, with no warranty.

Demo Machines – New machines that had limited usage performing test cuts for the purpose of demonstrating the machine capabilities. Sold with a full 1-year warranty.

VIEW MACHINES



CANCELED ORDERS

Brand-New, Custom Configured Machines

Never Used!

Canceled orders, fully inspected, and ready to ship with a standard 1-year warranty. These machines have never been installed, so don't miss out on these custom configured options at unbeatable prices!

VIEW MACHINES



Hot Deals 20% to 30% Off!
Demo Machines @ 15% to 30% Off!
Canceled Orders @ 15% to 30% Off!

HAE Marketing Update

CHOOSE YOUR FINANCING

**NO MODEL
RESTRICTIONS**

**UP TO 6-MONTH SKIP
AVAILABLE**

**NO PRE-PAYMENT
PENALTIES EVER!**

LOWEST DOWN PAYMENT
10% DOWN

4,99% Interest for as Long as 60-Months.

Payments as Low as
€1.698 PER MONTH

LOWEST INTEREST
0% FOR 48 MONTHS

Requires Larger Down Payment.

Payments as Low as
€1.042 PER MONTH

LONGEST TERM
84-MONTH TERM

With Rates as Low as 4,99%*

Payments as Low as
€707 PER MONTH

Sample payments are based on a €100.000 CNC machine purchase.

SAVE €8.388 IN INTEREST!

(Based on 0,00% for 36 months, compared to US Prime Lending Rate at 7.5% interest.)

INSANE FINANCING FOR YOUR NEXT HAAS CNC

DOWN PAYMENT	CHOOSE YOUR TERM						
	12-MONTHS	24-MONTHS	36-MONTHS	48-MONTHS	60-MONTHS	72-MONTHS	84-MONTHS
10% DOWN	0,00%	2,49%	3,49%	4,49%	4,99%	N/A	N/A
20% DOWN	0,00%	1,49%	2,49%	2,99%	4,49%	5,49%	5,99%
25% DOWN	0,00%	0,00%	1,49%	2,49%	3,49%	4,99%	5,49%
30% DOWN	0,00%	0,00%	0,00%	1,49%	2,99%	4,49%	4,99%
50% DOWN	0.00%	0.00%	0.00%	0.00%	2.99%	4.49%	4.99%
20% DOWN + 3-MO SKIP	1,49%	1,99%	2,99%	3,99%	5,49%	5,99%	6,49%
30% DOWN + 6-MO SKIP	1,99%	2,49%	3,49%	4,49%	N/A	N/A	N/A

*Financing terms, conditions, and exceptions: valid in Denmark, Germany, France, Spain, Portugal, Belgium, Luxembourg, Estonia, Latvia, Lithuania, Czech Republic, Slovenia, Slovakia, and Greece only. References are to an implied interest rate under a conditional sales contract. Interest accrues during the skip period. Down payment, rate, and terms of financing are dependent upon credit approval. Eligible businesses should have three or more years of operation under current ownership. All programs are 10% - 50% down. Must put a minimum of 20% down to get no payments for 3 months. **Certain equipment (e.g., stand-alone Rotaries, Shop Equipment, Bar Feeders, etc.) are subject to different rates, terms, and down-payment requirements, unless financed with a machine.** No prepayment penalty on any program. Monthly payment does not include applicable taxes, rigging, or freight charges.

Offer valid on new machine orders placed from **1 September through 30 September 2025.**

HAE Marketing Update

INSANE FINANCING FOR YOUR NEXT HAAS CNC

DOWN PAYMENT	CHOOSE YOUR TERM						
	12-MONTHS	24-MONTHS	36-MONTHS	48-MONTHS	60-MONTHS	72-MONTHS	84-MONTHS
10% DOWN	0,00%	2,49%	3,49%	4,49%	4,99%	N/A	N/A
20% DOWN	0,00%	1,49%	2,49%	2,99%	4,49%	5,49%	5,99%
25% DOWN	0,00%	0,00%	1,49%	2,49%	3,49%	4,99%	5,49%
30% DOWN	0,00%	0,00%	0,00%	1,49%	2,99%	4,49%	4,99%
50% DOWN	0,00%	0,00%	0,00%	0,00%	2,99%	4,49%	4,99%
20% DOWN + 3-MO SKIP	1,49%	1,99%	2,99%	3,99%	5,49%	5,99%	6,49%
30% DOWN + 6-MO SKIP	1,99%	2,49%	3,49%	4,49%	N/A	N/A	N/A

YOUR NEXT HAAS CNC

DOWN PAYMENT	CHOOSE YOUR TERM						
	12-MONTHS	24-MONTHS	36-MONTHS	48-MONTHS	60-MONTHS	72-MONTHS	84-MONTHS
10% DOWN	0,00%	1,99%	2,99%	3,99%	4,49%	N/A	N/A
20% DOWN	0,00%	0,99%	1,99%	2,49%	3,99%	4,99%	5,49%
25% DOWN	0,00%	0,00%	0,99%	1,99%	2,99%	4,49%	4,99%
30% DOWN	0,00%	0,00%	0,00%	0,99%	2,49%	3,99%	4,49%
40% DOWN	N/A	N/A	N/A	0,00%	N/A	N/A	N/A
20% DOWN + 3-MO SKIP	N/A	1,49%	1,99%	3,49%	4,99%	5,49%	5,99%
30% DOWN + 6-MO SKIP	N/A	1,99%	2,49%	3,99%	N/A	N/A	N/A

Did You Know...

Did You Know...

*** More to come about Premium vs. Standard Controls**

Control Version	Machines
Premium Control	VF, VR, VM, UMC, GM, GR, DC, DT, DM, UMC, EC, ST, DS, SR-P, MM
Standard Control	TM, TL, Desktop, SR, Pocket

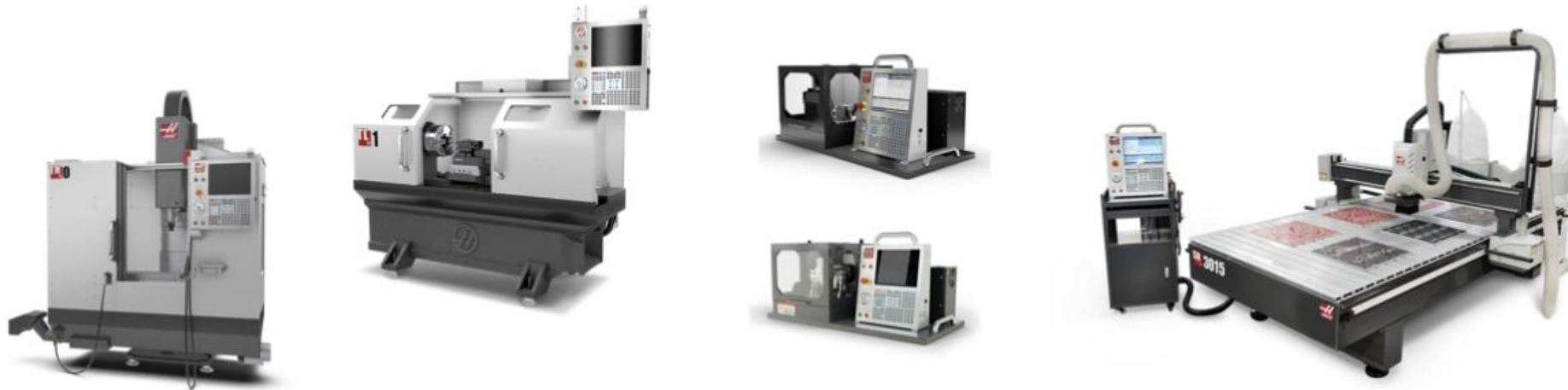

Did You Know...

* More to come about Premium vs. Standard Controls

Premium Control



Key Features

19" monitor

Touch Screen

New features will be added

Available on all machines but those listed under the 'Standard Control' list

Standard Control



Key Features

15" monitor

No touch screen (phase out)

No new features

Available on:

- TM, TL, Desktop, SR (non-P) & Pocket

Did You Know...



Mill Spindle C-Axis Drive

Starting Price: US\$14,995



- Mill, drill, and tap on multiple sides of a part
- Fully programmable interpolated motion
- Accurate positioning to nearly any angle
- Mounts to the mill spindle

Our Mill Spindle C-Axis Drive allows you to **accurately position right-angle milling heads to nearly any angle** for milling, drilling, and tapping on multiple sides of a part.

This is a **FULLY programmable axis that allows simultaneous motion** interpolated with the X, Y, Z, and even A axes, making it possible to reach difficult internal features, or perform simple end work on longer parts – operations not possible with traditional 3- or 4-axis set ups.

NOTE: Requires a side-mount tool changer. Requires a Haas mill with 4th-axis drive and NGC software version 100.21.000.1130. Machines with a single-axis rotary installed will require both 4th- and 5th-axis drives. Not compatible with 2-axis rotaries.

Currently available on new machines only. Not available for field installation.

We have changed the availability of the Mill Spindle C-Axis option on VFs to **ONLY** allow for build to order machines. No field installation, or reconfigure from stock (RFS), at this time.

DS Series Spindle Synchronization



DS-30Y

Starting Price: US\$174,995

The DS-30Y Y-axis turning center combines dual-spindle turning with Y axis, C axis, and live tooling to create a powerful "done-in-one" machining solution for any shop. Off-center milling, drilling, and tapping operations are possible for increased machining capabilities. It comes standard with a 12-station BMT65 turret and synchronized C axis for versatile 4-axis capability. The opposed spindles support fully synchronized turning, and allow on-the-fly part pass-off to reduce cycle times. The DS-30Y has a medium footprint, yet provides a generous work envelope.

The DS-30Y has a medium footprint, yet provides a generous work envelope. The sub-spindle has a full C-axis for accurate positioning and interpolated live-tooling operations, and a mechanical brake that provides 140 ft-lb (190 Nm) of holding torque for off center milling and drilling.

- Dual-spindle design for done-in-one operations
- Y-axis milling, drilling, and tapping
- Fully interpolated sub-spindle C-axis with mechanical brake
- Fully synchronized part pass-off (up to 4000 rpm)
- Ideal for high-volume, high-production environments

Current Lead Time [↗](#)

5 Weeks - Contact your local HFO for delivery times.

On the DS30Y the max sync speed would be the **4,000 rpm** by way of the max **secondary spindle** speed.
 For the DS25Y it would be **3,400 rpm** by way of the max **main spindle** speed.
 For the DS20Y it would be **4,000 rpm** by way of the max **main spindle** speed.

Haas 30 kg Cobot Package

BUILD-&-PRICE

i MACHINE INFO

☰ SPECS



SINGLE GRIPPER

	S.A.E	METRIC
Max Part Weight	48.0 lb	21.8 kg
Gripper Assembly Weight	16.3 lb	7.4 kg
Part Size - Round \varnothing	0.75 in to 8.00 in	19 mm to 203 mm
Part Width - Rectangular	0.50 in to 6.50 in	13 mm to 165 mm

DUAL GRIPPER

	S.A.E	METRIC
Max Part Weight (per gripper)	19.8 lb	9.0 kg
Gripper Assembly Weight	26.4 lb	12.0 kg
Part Size - Round \varnothing	0.63 in to 6.00 in	16 mm to 152 mm
Part Width - Rectangular	0.51 in to 6.00 in	13 mm to 152 mm

Did You Know...

New Dual Gripper for HRP-1 & HC10

7kg Robot

Increased from
2.5 lb. to 5 lb.
2 Xs Increase

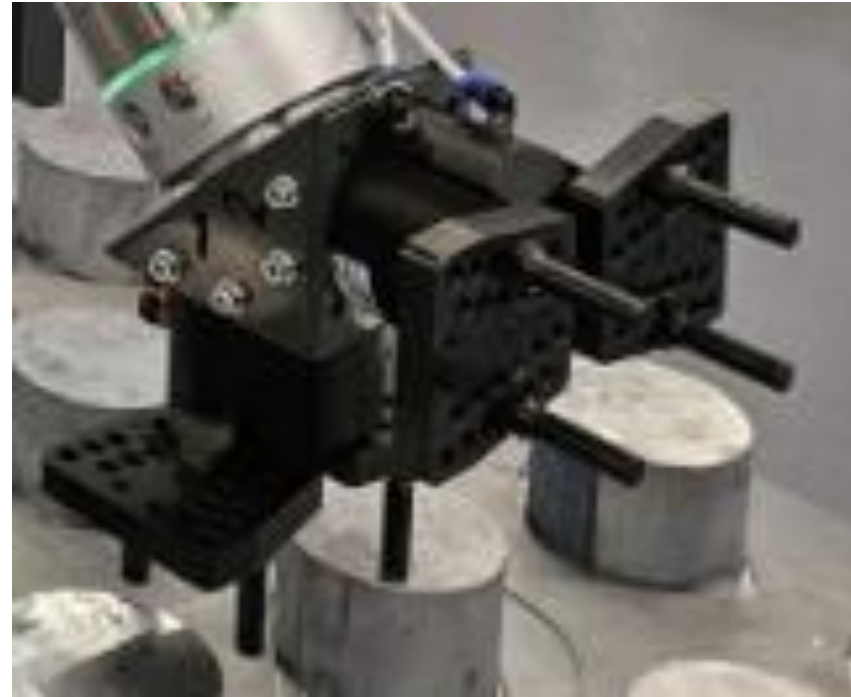

Previous version



10kg Cobot

Increased from
2.5 lb. to 6.3 lb.
2.5 Xs Increase

We changed to a higher capacity gripper for Dual Gripper on Robot Pkg-7KG, Robot Pkg-1, and Cobot Pkg-10KG in June.

SB Series Haasification...

- Control Cabinet
- Control Pendant
- CALM Cabinet
- Servo Motors
- Spindle Motor
- ATP
- Chip Strainer
- Coolant Pumps
- Coolant Washdown Hose
- Haas Live Tools



Did You Know...



Did You Know...

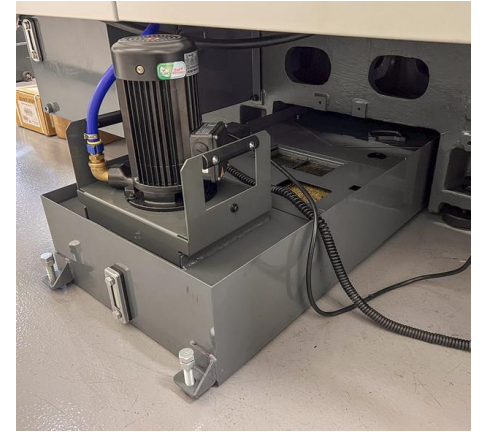
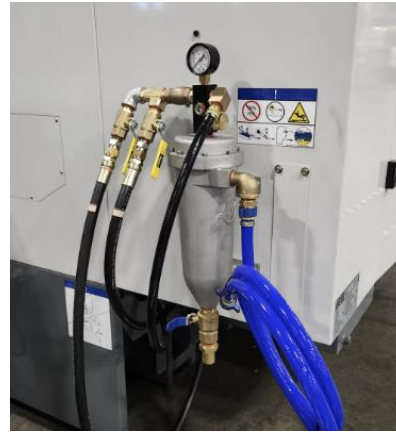
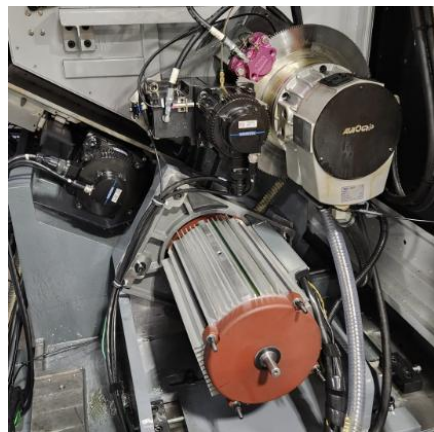

Did You Know...

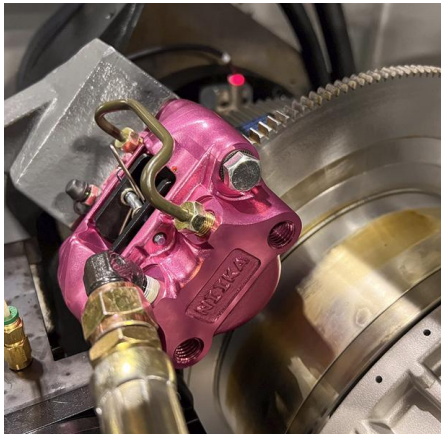
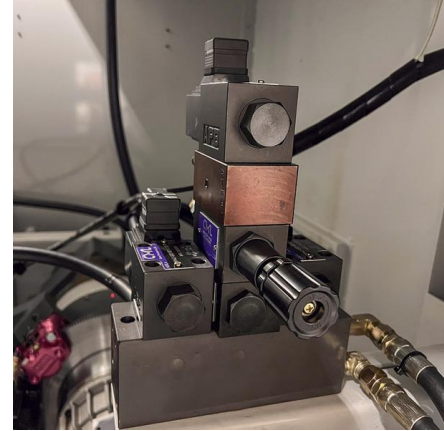
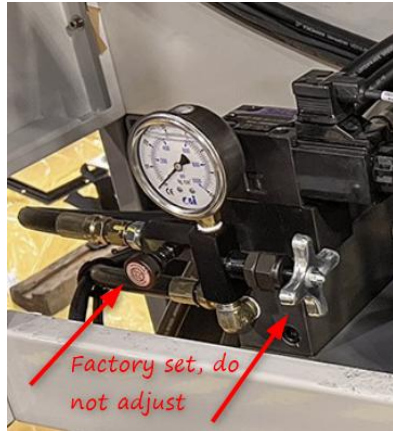
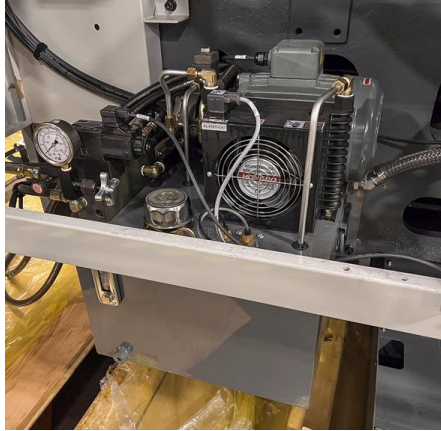

Shop Support - Apps & Service Training

We're planning a two-day Apps & Service training event for Shop Support Equipment

Dates: October 8th and 9th, 2025

Time: 8:00 AM – 4:30 PM

Product Coverage:

- HMM430
- Haas Tool Setters & Haas Shrink Fit Series
- HL50E
- All Saws

Training Topics:

- Unboxing & Safety Precautions
- Installation
- Startup & Basic Operation
- General and Advance Operation
- Technical Troubleshooting

Please email Bryan O'Fallon directly with any names, email addresses & job functions for those interested in attending.

Factory Training

- Factory Training Dates for 2025
 - December 3/4

Please email Scott Gasich directly with any names, email addresses and job functions for those who will be attending



THANK YOU!
FOR ALL YOUR EFFORTS



HMAS

